

K - KA - K AC

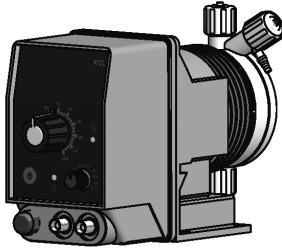

PRODUCT LABEL



K

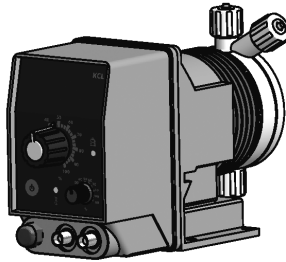

KA

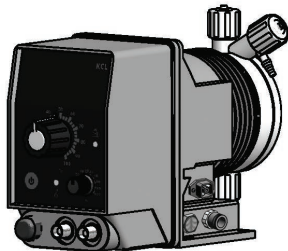

K AC

SOLENOID DRIVEN METERING PUMPS
WITH DIAPHRAGM

EN

OPERATING MANUAL



This operating instructions contains safety information that if ignored can endanger life or result in serious injury.

Read these instructions **carefully** before use and keep them for future reference. The original instruction is in Italian. All non-Italian instructions are translations of the original instruction.

Information and specifications on this manual could be uncorrect or could have printing errors. Specifications are subject to change without notice.

Version: R1-11-13



**NORME CE
EC RULES (STANDARD EC)
NORMAS DE LA CE**

Direttiva Basso Voltaggio
Low Voltage Directive
Directiva de baja tensión } **2006/95/CE**

Direttiva EMC Compatibilità Elettromagnetica
EMC electromagnetic compatibility directive
EMC directiva de compatibilidad electromagnética } **2004/108/CE**

Norme armonizzate europee nell'ambito della direttiva
European harmonized standards underdirective
Las normas europeas armonizadas conforme a la directiva } **2006/42/CE**



K metering pump is tested and certified by WQA to NSF/ANSI 50 and 61 for materials safety.

GENERAL SAFETY GUIDELINES

Operating, installing, or maintaining the unit in any way that is not covered in this manual could cause death, serious personal injury, or damage to the equipment.

ICON

This manual use the following safety message icon:



Danger!

Indicates a hazardous situation which, if not avoided, will result in death or serious injury.



Warning!

Indicates a hazardous situation which, if not avoided, could result in death or serious injury.



Important - A practice not related to personal injury or additional information.



Cross reference - An instance which refers to related information elsewhere in the same document

**PURPOSE OF USE
AND SAFETY**











**METERING PUMP IS INTENDED FOR CHEMICAL DOSING AND DRINKING WATER
TREATMENT.**

Do not use in explosive area (EX).
Do not use with flammable chemicals.
Do not use with radioactive chemicals.

Use after a proper installation.

Use the pump in accordance with the data and specifications printed on the label.

Do not modify or use in a manner inconsistent with the provisions of the operating manual.

-  **Keep the pump protected from sun and water. Avoid water splashes.**
-  **In emergencies the pump should be switched off immediately. Disconnect the power cable from the power supply.**
-  **When using pump with aggressive chemicals observe the regulations concerning the transport and storage of aggressive fluids.**
-  **When installing always observe national regulations.**
-  **Manufacturer is not liable for any unauthorized use or misuse of this product that may cause injury, damage to persons or materials.**
-  **Pump must be accessible at all times for both operating and servicing. Access must not be obstructed in any way.**
-  **Feeder should be interlocked with a no-flow protection device.**
-  **Pump and accessories must be serviced and repaired by qualified and authorized personnel only.**
-  **Before any operation:**
 - always read chemical Material Safety Data Sheet (MSDS);
 - always wear protective clothing;
 - always discharge the liquid end before servicing the pump.
 - empty and rinse the liquid end before work on a pump which has been used with hazardous or unknown chemicals.
-  **This equipment requires regular maintenance to ensure potability requirements of the water and maintenance of improvements as declared by the manufacturer.**

ENVIRONMENTAL SAFETY

Work area

Always keep the pump area clean to avoid and/or discover emissions.

Recycling guidelines

EWC code: 16 02 14

Always recycle according to these guidelines:

1. If the unit or parts are accepted by an authorized recycling company, then follow local recycling laws and regulations.
2. If the unit or parts are not accepted by an authorized recycling company, then return them to the nearest representative.

Waste and emissions regulations

Observe these safety regulations regarding waste and emissions:

- Dispose appropriately of all waste.
- Handle and dispose of the dosed chemical in compliance with applicable environmental regulations.
- Clean up all spills in accordance with safety and environmental procedures.
- Report all environmental emissions to the appropriate authorities.

LABEL

Fig. 1. Product label.

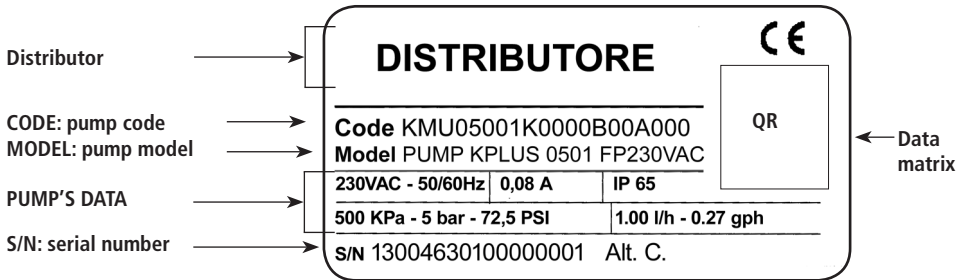

SPARE PARTS

For spare parts orders or any other communication, refer to the pump's label. Code (CODE) and serial number (S / N) uniquely identify the pump.

Fig. 2. WQA label.



THIS METERING PUMP IS TESTED AND CERTIFIED BY WQA TO NSF/ANSI 50 AND 61 FOR MATERIALS SAFETY.

**TRANSPORTATION
AND STORAGE**

i A not suitable transportation or storage can cause damages.

Use original box to pack the pump.

Observe storage conditions also for transportation.

Although packed, always protect the unit against humidity and the action of chemicals.

⚠ Before return the dosing pump to the manufacturer Repair service, drain the chemical from pump head and rinse it. Refer to  Shutdown procedure.

Fill the PRODUCT SERVICE REPAIR FORM and send it with the dosing pump.
Repair service is not accepted if PRODUCT SERVICE REPAIR FORM is missing.

i DO NOT TRASH PACKAGING. USE IT TO RETURN THE PUMP.

Transportation and storage temperature 10 ÷ 50°C (32 ÷ 122°F)
Umidity..... 95% relative humidity (not condensed)

1. Introduction

1.1 K Series



NSF/ANSI 61

K metering pumps are the ideal solution for low / middle dosing of chemicals.

Flow rate is determined by the stroke length and by the stroke speed. The stroke length is adjustable from 0 to 100% using the stroke length adjustment knob. However dosing accuracy is guarantee within an adjustment range from 30% to 100%.

1.2 KA Series



NSF/ANSI 61

KA is the K version with **self-venting pump head**.

Self-venting pump head must be used when using chemicals that produce gas (i.e. hydrogen peroxide, ammonium, sodium hypochlorite at particular conditions).

For connections  "**Self-Venting pump head installation**".

1.3 K AC Series

KAC is the K version with **double supply: compressed air and power supply**. Compressed air without lubricant and/or condensed water. Air supply pressure range must be from 6 to 10 bar.

For connections  p. 8.

1.4 Models

Each series is available in different models:

SERIES			MODEL	HOW DOES IT WORK
K	KA	K AC	CO	Constant pump with stroke speed (frequency) adjustment
K	KA	K AC	CL	Constant pump with level control, stroke speed (frequency) adjustment
K	KA	-	IS	Constant-proportional pump driven by external digital signal with level control: to each external pulse correspond one pump stroke
K	KA	-	PV	Constant-proportional pump driven by external digital signal with pulse divider mode (ratio 1 to 1000) and level control
K	KA	-	PVM	Constant-proportional pump driven by external digital signal, level control, with pulse divider mode (ratio 1 to 100) and multiplier mode (ratio 1 to 10)
K	KA	-	IC	Constant-proportional pump driven by current signal (0/4mA = 0 pulses; 20mA = max pulses) and level control

1.5 Capacity

K	
Pressure (bar)	Flow (l/h)
20	1
18	2
15	4
10	5
8	8
5	10
5	1
3	1
2	18

KA	
Pressure (bar)	Flow (l/h)
18	1
15	3
10	3,5
8	5,5
5	7,5
2	13

K AC	
Pressure (bar)	Flow (l/h)
10	18

2. Unpacking



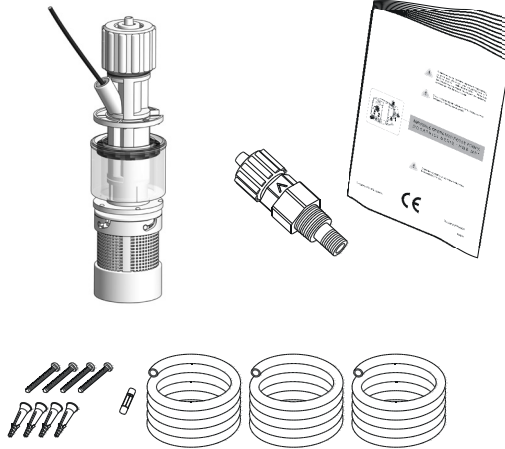

<i>Included into package:</i>	n.4	Dibbles $\varnothing 6$
	n.4	Self tapping screws 4,5 x 40
	n.1	Fuse
	n.1	Foot filter with valve
	n.1	Injection valve
	n.1	Level probe
	m 2	Delivery pipe* (PVDF)
	m 2	Suction pipe * (transparent PVC)
	m 2	Venting pipe (transparent PVC)
	n.1	This installation manual

* If hose is 6x8 there is only a 4meters long hose.
Cut to obtain suction and delivery hoses.

Remove the contents from the box.



Legend:

- a. Alternating Current; 
- b. DC, 
- c. Protective Earth; 
- d. Standby; 
- e. Warning - 

Self venting pump head (mod. KA)

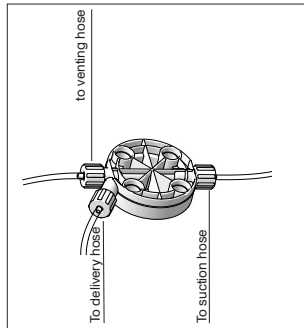

* Stroke length Knob

The main illustration shows the pump unit from a top-down perspective. It features a large black control panel with a 'KNOB' for stroke length, a power button, and two indicator lights. On the right side, there are two circular ports for level and external signal inputs. On the left side, there are two venting knobs. The pump head is mounted on top.

to delivery hose

Venting knob knob

to venting hose

Pump head

to suction hose

Alimentazione aria compressa (solo mod. K AC)

Sfiato per elettrovalvola (solo mod. K AC)

Level probe input

External Signal input

to power supply

* Press to turn.
To avoid pump's damage, turn the knob when the pump is on.

4. Before to Install warnings

Pump's installation and operativity is made in 4 main steps:

Pump's installation
Hydraulic Installation (hoses, level probe, injection valve)
Electrical Installation (main power connection, priming)
Programming the pump.

Before to start, please read carefully the following safety information.

Protective clothes



Wear always protective clothes as masks, gloves, safety glasses, ear plugs or ear muffs and further security devices during ALL installation procedure and while handling chemicals.

Installation location



Pump must be installed in a safety place and fixed to the table / wall to avoid vibration problems!

Pump must be installed in a easy accessible place!

Pump must be installed in horizontal position!

Avoid water splashes and direct sun!

Hoses and Valves



*Suction and delivery hoses must be installed in vertical position!
All hoses connections must be performed using only hands' force!
No tongs required!*

Delivery hose must be firmly fixed to avoid suddenly movements that could damage near objects!

Suction hose must be shorter as possible and installed in vertical position to avoid air bubbles suction!

Use only hoses compatibles with product to dose! See Chemical Compatibility Table. If dosing product is not listed please consult full compatibility table or contact chemical's manufacturer!



Feeder should be interlocked with a no-flow protection device to automatically shut-off the pumps when there is no flow!



Adequate measures shall be taken to prevent cross connection of chemicals!



Chemical feeding must be stopped during backwash cycles and periods of noflow as these conditions may introduce the potential for chemical overdosing. Not doing so may result in elevated chemical concentrations and hazardous gas introduction into the pool or spa.

5. Installation Draw

Pump must be installed in a stable support (for example a table) at a maximum height (from tank's bottom) of 1,5 meters.

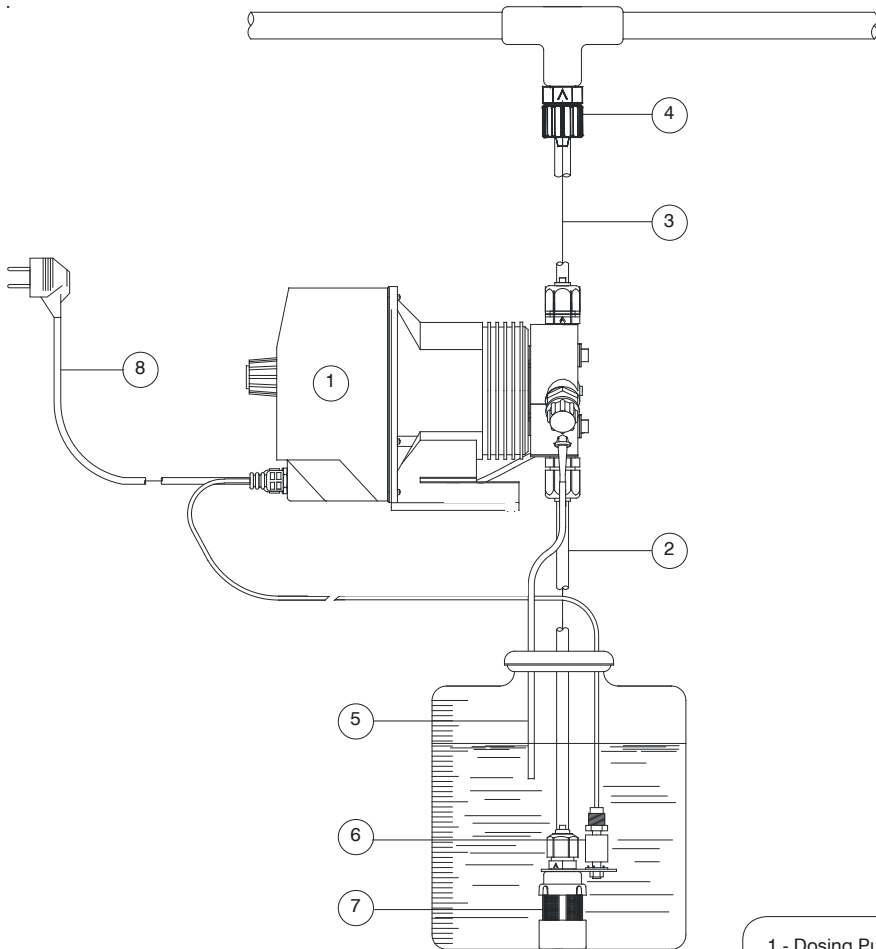

- 1 - Dosing Pump
- 2 - Suction Hose
- 3 - Delivery Hose
- 4 - Injection Valve
- 5 - Air discharge
- 6 - Level Probe
- 7 - Foot Filter
- 8 - Power Cable

6. Hydraulic Installation

Hydraulic connections are:

Suction Hose with level probe and foot filter
Delivery Hose with injection valve
Venting hose

Suction Hose.

Completely unscrew tightening nut from pump's head and remove assembling components: *tightening nut, holding ring and pipe holder.*

Assembly as shown in fig. (A). Insert hose into pipe holder until it reaches the bottom.

Lock hose on pump's head by screwing down the tightening nut.
Use only hands to do it!

Connect other side of the hose to the foot filter using the same procedure.

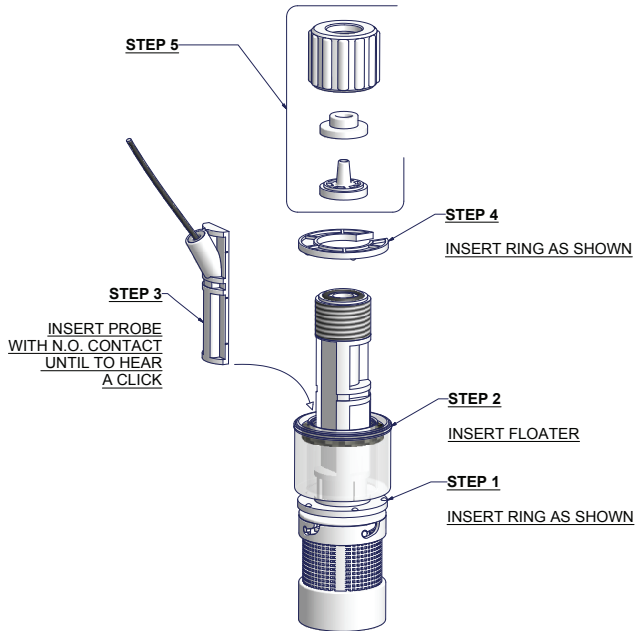

fig. (A)

6. Hydraulic Installation

Assembling foot filter with level probe.

Level probe must be assembled with foot filter using the provided kit.
Foot valve is made to be installed into tank's bottom without sediments priming problem.



Connect BNC from level probe into pump's level input (front side of the pump).
Put level probe assembled with foot filter into tank's bottom.

Warning: If there is a mixer installed into tank, install a suction lance instead of level probe / foot filter.

Delivery Hose.

Completely unscrew tightening nut from pump's head and remove assembling components: *tightening nut, holding ring and pipe holder*.

Assembly as shown in fig. (A). Insert hose into pipe holder until it reaches the bottom.

Lock hose on pump's head by screwing down the tightening nut.
Use only hands to do it!

Connect other side of the hose to the injection valve using the same procedure.

6. Hydraulic Installation

Injection Valve.

Injection valve must be installed on plant from water's input.
Injection valve will open at pressure greater than 0,3bar.

Discharge hose.

Insert one side of venting hose into discharge connector as shown in fig (C).

Insert other side of venting hose into product's tank.
During priming procedure product exceeding will flow into tank.

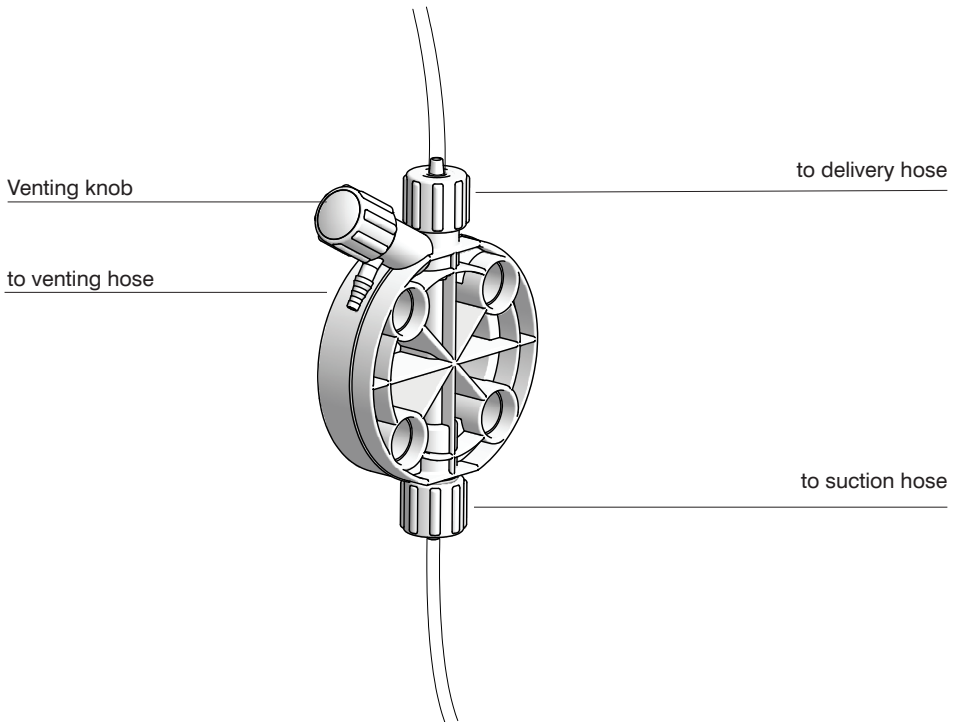
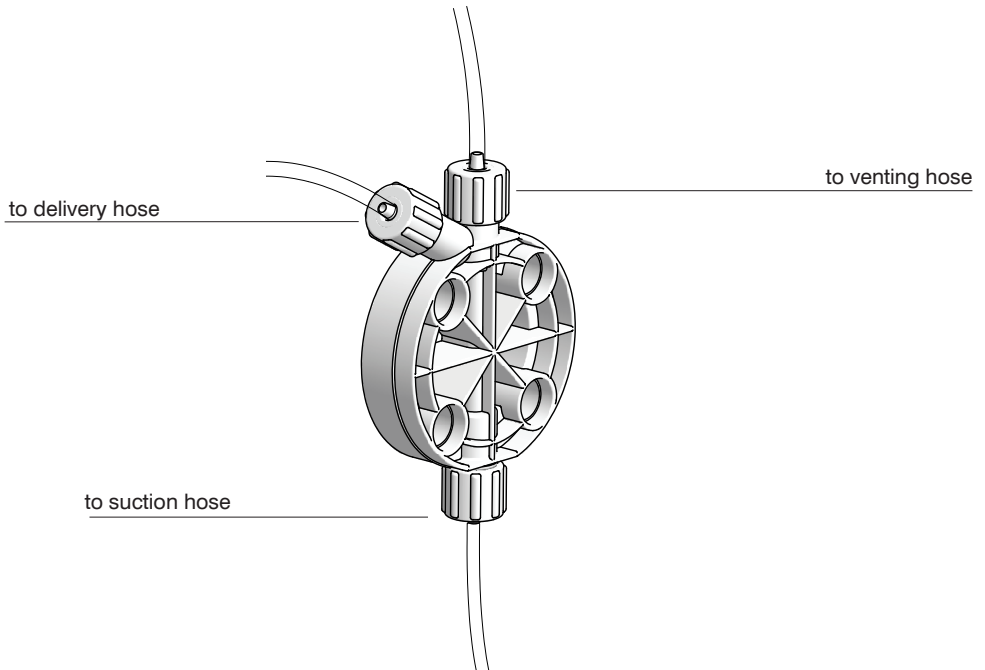

fig (C)

For priming procedure see the paragraph "Priming".

6. Hydraulic Installation

Self-venting pump head.



Self-venting pump head must be used when using chemicals that produce gas (i.e. hydrogen peroxide, ammonium, sodium hypochlorite at particular conditions).

Hoses assembling procedure (*including purge hose*) is described in fig. (A).

Notes:

- suction, delivery and purge valves are DIFFERENT! Do not exchange them!
- delivery and purge hoses are made of same material!
- it's allowed to lightly bend venting hose!
- during calibration procedure ("TEST") insert venting hose into BECKER test-tube!

7. Electrical Installation

All electrical connections must be performed by AUTHORIZED AND QUALIFIED personnel only. Before to proceed, please, verify the following steps:

- verify that pump's label values are compatible with main power supply.
- pump must be connected to a plant with a differential switch (0,03A sensitivity) if there isn't a good ground.
- to avoid damages to the pump do not install it in parallel with heavy inductance load (for example: engines). A relay switch must be used. See below picture.

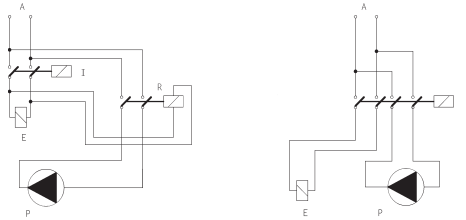

*P - Dosing Pump
R - Relay
I - Switch or safety device
E - Electrovalve or inductance load
A - Main Power*



WARNING
IF EQUIPMENT IS SUPPLIED WITH A PLUG:

If an appliance coupler or separable plug is used as the disconnecting device, it shall be readily identifiable and easily reached by the operator. For single-phase portable equipment, a plug on a cord of length not greater than 3m is considered to be easily reached.



WARNING
IF EQUIPMENT IS NOT SUPPLIED WITH A PLUG:

- a) a switch or circuit-breaker shall be included in the building installation
- b) it shall be in close proximity to the equipment and within easy reach of the operator
- c) it shall be marked as the disconnecting device for the equipment

7. Electrical Installation

Once verified previous steps proceed as follows:

- check that “BNC” of level probe has been connected as described in “Hydraulic Installation” chapter.
- connect “BNC” and external signal to pump’s “INPUT” connectors.

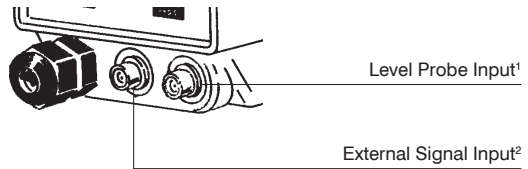

¹ Level probe input available on models: KIC, KIS, KPV, KPVM, KCL

² External signal input available on models: KIC, KIS, KPV, KPVM

8. Models

LEVEL ALARM

CL, IS, IC, PV and PVM type pump are provided with a liquid level alarm to indicate product tank is empty. The level probe is connected to the right BNC plug on pump's bottom panel. The level probe is made of a N.O. reed contact (10VA, 1A max., 230Vac max.) closed by a floating magnet housed in a (PP) plastic box. When the product level goes below the minimum the magnet closes the reed contact. The pump stops and the red LED on pump's front panel indicates the alarm status.

PUMP TYPES

Pumps mod. "KCL" (12-24 Vac/Vdc), "KIC", "KIS", "KPV" and "KPVM" are equipped with a bicolour led.

Led on, red colour: low level product alarm. Check product's tank and restore the level.

Led on, blinking green colour: pump normal operating mode.

Led on, blinking green colour (one second on, one second off): power supply out of range. Check pump's label and check the main power.

KCO

Constant dosing pump with stroke speed adjustment between 0 and 100% of indicated capacity (see label on pump type). The % marked knob sets the pump capacity, changing linearly the magnet stroke number per minute. It is strongly suggested to not operate the pump in the range from 0 to 10%, since there is not a linear correlation with the pump stroke speed in that range. This pump is specially designed for constant dosing rates. KCO pump can be ON/OFF driven by a LPH or a LCD instrument. To set 2.5 l/h against 5 bar on a KCO 0505 the % marked knob should be set to 50%.

KCO has a divider ($\times 0,1$) to reduce by ten times the pump capacity by dividing the pump stroke speed.

How to enable "divider mode":

- set the pump into OFF* mode;
 - keeping pressed the on/off button, wait 3 flashes from the status led. The pump will start the dosing activity with the stroke speed reduced ten times than the value set on stroke length knob.
- To disable the "divider mode", power OFF the pump. Keeping pressed the on/off button, wait 3 flashes of the status led.

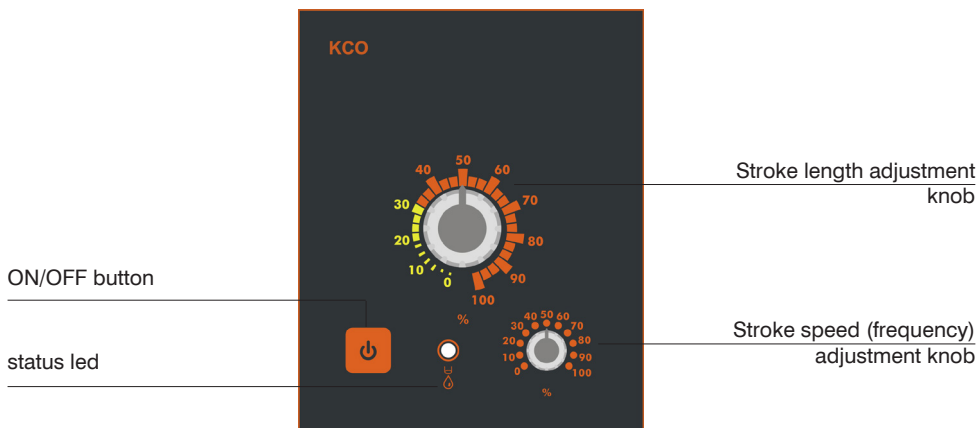

LED

The led on the frontal panel shows the pump's operating status through 5 flashing:

LED ACTIVITY	PUMP'S STATUS
It flashes 3 times per second	the pump is powered with a power supply lower than the label
It flashes 2 times per second	the pump is powered with a power supply higher than the label
It flashes 1 time every 2 seconds	the pump is in pause (OFF) and it is powered (OFF* mode)
led ON, it switches off when pump strokes	the pump is active and functioning (ON)
led ON, it switches off 1 time every 2 seconds	the pump is working into DIVIDE mode

kCL

Constant dosing pump with level alarm, provided with a floating magnetic sensor probe.

A red led indicates that the pump stopped dosing because the product tank is empty.

This pump has stroke speed adjustment between 0 and 100% of indicated capacity (see label on pump type).

The % marked knob sets the pump capacity, changing linearly the magnet stroke number per minute. It is strongly suggested to not operate the pump in the range from 0 to 10%, since there is not a linear correlation with the pump stroke speed in that range.

kCL has a divider ($x- 0,1$) to reduce by ten times the pump capacity by dividing the pump stroke speed.

How to enable “divider mode”:

- set the pump into OFF* mode;

- keeping pressed the on/off button, wait 3 flashes from the status led. The pump will start the dosing activity with the stroke speed reduced ten times than the value set on stroke length knob.

To disable the “divider mode”, power OFF the pump. Keeping pressed the on/off button, wait 3 flashes of the status led.

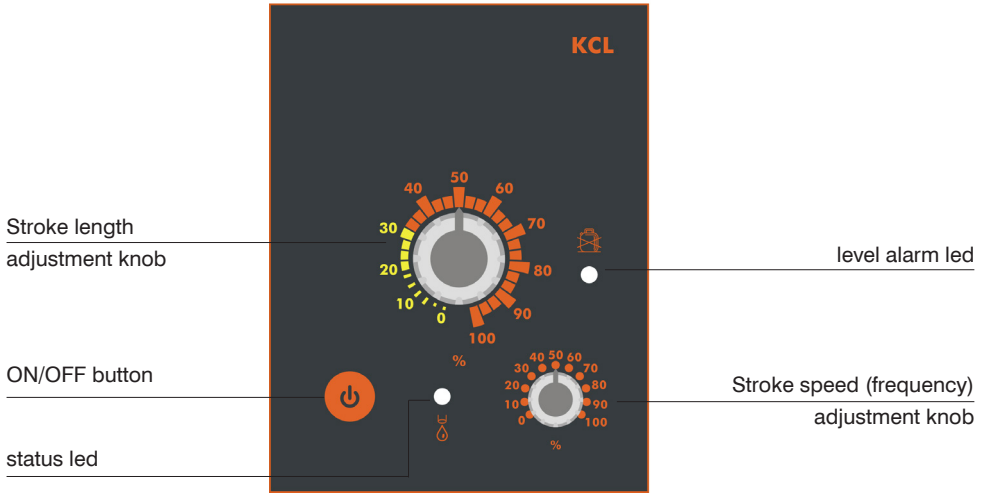

LED

The led on the frontal panel shows the pump’s operating status through 5 flashing:

LED ACTIVITY	PUMP’S STATUS
It flashes 3 times per second	the pump is powered with a power supply lower than the label
It flashes 2 times per second	the pump is powered with a power supply higher than the label
It flashes 1 time every 2 seconds	the pump is in pause (OFF) and it is powered (OFF* mode)
led ON, it switches off when pump strokes	the pump is active and functioning (ON)
led ON, it switches off 1 time every 2 seconds	the pump is working into DIVIDE mode

KIC

Proportional/constant pump driven by current signal.

Setting the switch on the *constant*  position the pump has stroke speed adjustment between 0 and 100% of indicated capacity (see label on pump type). The % marked knob sets the pump capacity, changing linearly the magnet stroke number per minute. It is strongly suggested to not operate the pump in the range from 0 to 10%, since there is not a linear correlation with the pump stroke speed in that range.

Setting the switch on the *proportional*  position the pump capacity is set proportionally to a given analog current signal; a given signal linear change will be followed by a linear change of capacity.

The current signal accepted range is 0÷20 mA (it can be changed upon demand). The maximum pump capacity requested by the maximum input signal is set by the % marked knob. The IC pump can be driven by any electronic device (such as pH-meter, redox-meter, etc) that gives an analog current signal output. This signal must be applied to the bipolar cable provided with the pump, already internal connected, taking care of connections:

- red wire : *positive (+)*
- black wire : *negative (-)*

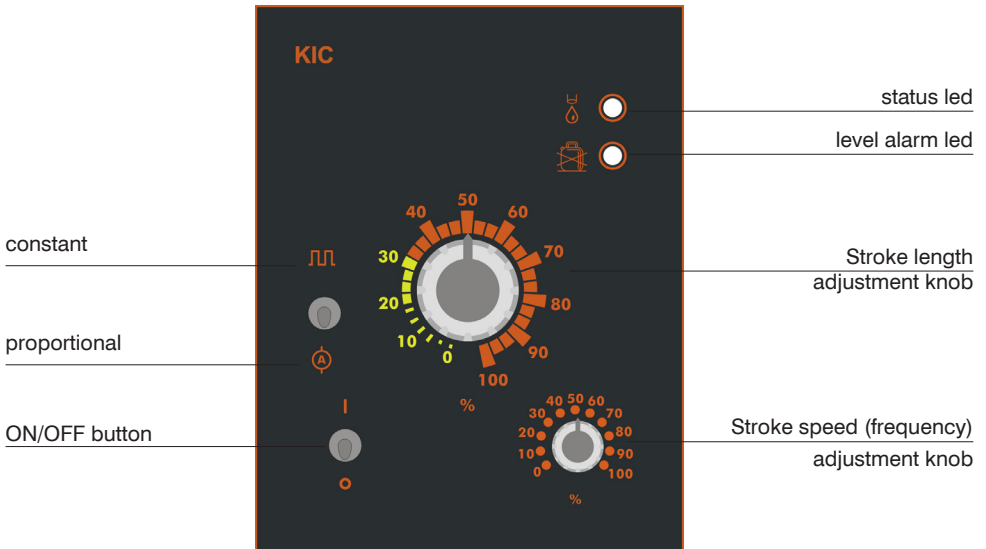

KIS

Proportional/constant pump driven by a digital signal.

Setting the switch on the *constant*  position, the pump has stroke speed adjustment between 0 and 100% of indicated capacity (see label on pump type). The % marked knob sets the pump capacity, changing linearly the magnet stroke number per minute. It is strongly suggested to not operate the pump in the range from 0 to 10%, since there is not a linear correlation with the pump stroke speed in that range.

Setting the switch on the *proportional*  position, to each external voltage free pulse correspond a magnet stroke. When proportional position is set, the % marked knob does NOT affect the pump capacity. IS proportional dosing pump can be driven by any external device (PCs, PLCs, etc) that produce a digital signal. The digital signal (N.O. contact) must be applied to the cable provided with the pump, already internal connected. If the digital signal is produced by an "Open Collector" transistor take care of connections:

- red wire : *positive (+)*
- black wire : *negative (-)*

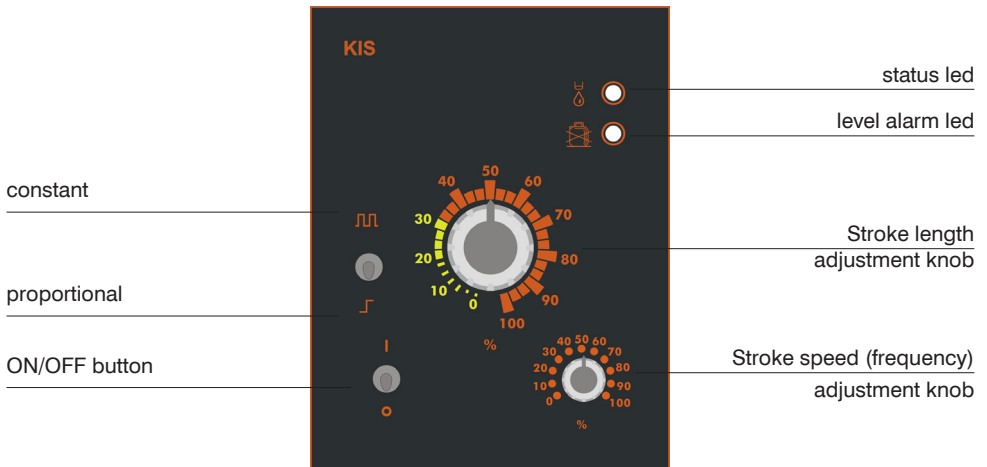

KPV

Proportional/constant pump driven by a water meter digital signal.

Setting the switch on the *constant*  position, the pump has stroke speed adjustment between 0 and 100% of indicated capacity (see label on pump type). The % marked knob sets the pump capacity, changing linearly the magnet stroke number per minute. It is strongly suggested to not operate the pump in the range from 0 to 10%, since there is not a linear correlation with the pump stroke speed in that range. It is furthermore possible to divide the maximum magnet strokes per minute by 1, 10 and 100 using the switch on the front panel.

Setting the switch on the *proportional*  position, to each external pulse correspond one pump stroke. This pump can be driven by a CTFI or CWFI series water meters. This pump can also be driven by a digital signal coming from a voltage free contact. Driving signal is applied on the BNC plug on the left of the bottom pump cover. Dividing factor (N) value is obtained multiplying the indicated value on the adjustment knob by the multiplying switch (x1, x10, x100) value.

Capacity definition for "KPV" pump

Given the water m^3 to be treated and the product amount to dose in p.p.m., the minimum pump capacity to be used can be obtained with the following formula:

$$\frac{\text{ppm} \times K \times m^3}{1000} = l/h$$

l/h - minimum pump capacity required
ppm - product amount to dose in p.p.m. (gr/ m^3)
k - dosed product dilution factor (pure chemical $k=1$)
m³ - maximum capacity of the system to be treated in m^3 /h.

Dividing factor (N) to be set on the adjustment knob is given by the following formula:

$$\left(\frac{\text{imp/l} \times \text{cc}}{\text{ppm} \times K} \right) \times 1000 = N$$

N - is the number the external pulses are divided by to be set on the adjustment knob
imp/l - pulse per liter given by the water meter
cc - pump's single stroke dosing quantity (in cc). Refer to following table
k - dosed product dilution factor (pure chemical $k=1$)
*ppm** - product amount to dose in p.p.m. (gr/ m^3)
* 10.000 ppm equals to 1%

Modello	cc
2001	0.1
1802	0.19
1504	0.37
1005	0.46
0808	0.76
0510	0.93
0218	0.5

If the dividing factor (N), obtained with the above formula, is < 1 , a pump with higher single stroke dosing quantity is required or the water meter needs to be changed with one that gives higher number of pulses per liter. In some application this issue can be solved reducing the dosed product dilution factor. If dosed amount is higher than the needed one, the set dividing factor (N) can be increased.

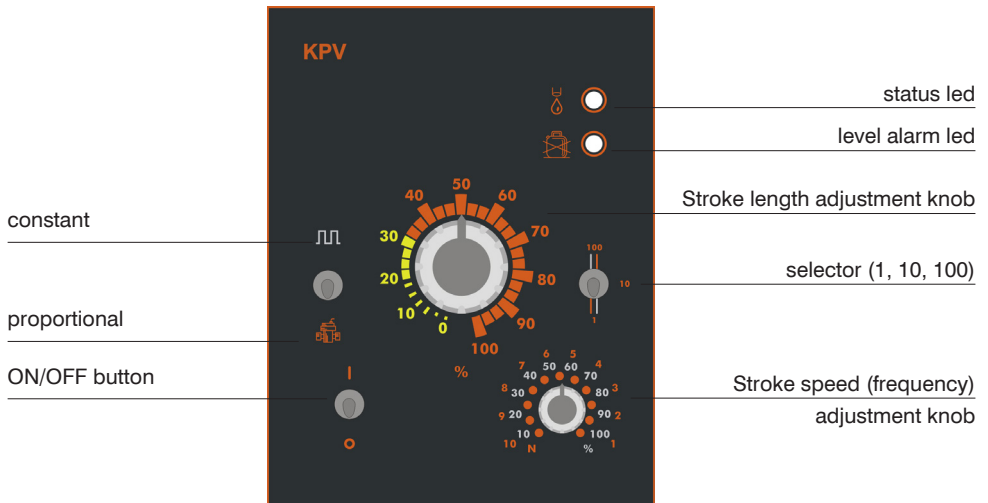

KPVM

Proportional/constant pump driven by a water meter digital signal.

Setting the switch on the *constant*  position, the pump has stroke speed adjustment between 0 and 100% of indicated capacity (see label on pump type). The % marked knob sets the pump capacity, changing linearly the magnet stroke number per minute. It is strongly suggested to not operate the pump in the range from 0 to 10%, since there is not a linear correlation with the pump stroke speed in that range. It is furthermore possible to divide the maximum magnet strokes per minute by 1 ($\div 1$), 10 ($\div 10$) and 100 ($\div 100$) using the switch on the front panel. The electronic capacity adjustment sets the injection per minute.

If the pump is set to Proportional mode, please ignore all the grey settings on the face of the pump. In Proportional mode, you only use the settings labelled in Orange, i.e. the colour of the water meter symbol on the face of the pump.

Set the selector switch to x1, /1 or /10.

In Proportional mode, the Stroke Frequency adjustment knob becomes a Factor Setting, eg 1, 2, 3 etc.

This factor is used to multiply or divide the pulses.

For instance, if the selector switch is set to x1, and the Factor Setting is set to 5, the pump will stroke 5 times for every pulse received.

Conversely, if the selector switch is set to /1, and the Factor Setting is set to 4, say, the pump will only give 1 stroke very 4 pulses received.

This pump can be driven by a CTFI or CWFI series water meters. This pump can also be driven by a digital signal coming from a voltage free contact. Driving signal is applied on the BNC plug on the left of the bottom pump cover.

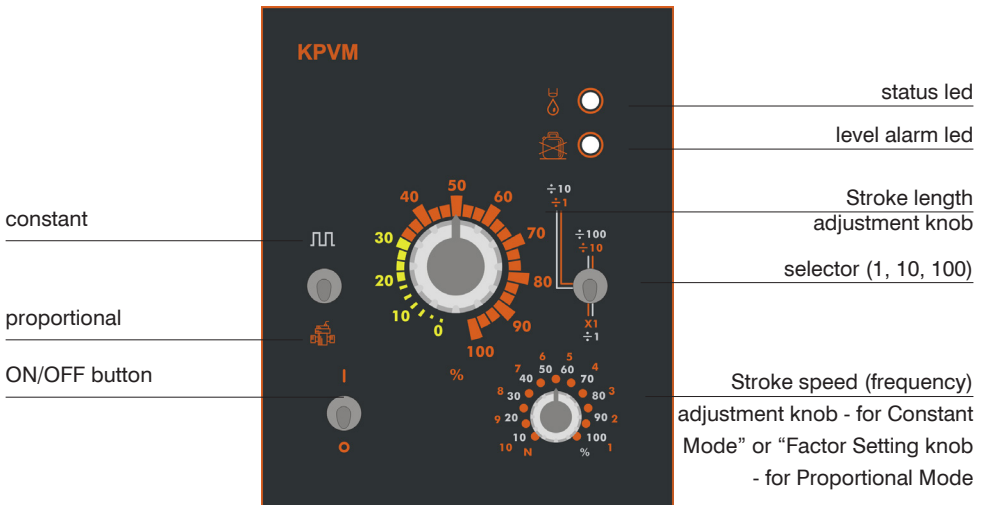

9. Priming

PRIMING

On the pump head there is a venting hose (left side).

To prime the pump without touching the chemical proceed as follow:

1. connect the transparent hose to the venting hose and insert its end into the chemical tank;
2. open the discharge valve turning the knob;
3. turn on the pump and set the stroke length adjustment knob on 100% and the stroke speed (frequency) adjustment knob on 100% (between 50% and 70% for high viscosity chemicals).
4. All air inside the pump will exit through the discharge valve. When the chemical begin to flow into venting hose, close immediately the venting knob.

If the chemical is particularly dense, to facilitate the priming:

1. turn on the pump and open the discharge valve;
2. insert a 20cc syringe into the venting hose and suck;
3. when the syringe is near to full, close the discharge valve.

10. Troubleshooting

Problem	Possible Cause
<p>Pump doesn't turn on.</p>	<p style="text-align: center;"><i>Pump isn't powered. Connect it to main supply.</i></p> <p style="text-align: center;"><i>Pump's protection fuse is broken. Replace it. See page 26 for replacement procedure.</i></p> <p style="text-align: center;"><i>Pump's main board is broken. Replace it. See page 26 for replacement procedure.</i></p>
<p>Pump is not dosing and solenoid is operating.</p>	<p style="text-align: center;"><i>The foot filter is obstructed. Clean it.</i></p> <p style="text-align: center;"><i>Suction hose is empty. Pump must be primed. Repeat priming procedure.</i></p> <p style="text-align: center;"><i>Air bubbles inside hydraulic circuit. Check valves - hoses - fittings.</i></p> <p style="text-align: center;"><i>Product to dose is generating gas. Turn venting knob and let air flow away.</i></p> <p style="text-align: center;"><i>Use a self-venting pump head.</i></p>
<p>Pump is not dosing and solenoid isn't operating or slightly operating.</p>	<p style="text-align: center;"><i>Crystals presence inside valves. Check them and try to dose 2-3 liters of normal water. Change valves.</i></p> <p style="text-align: center;"><i>Injection valve obstructed. Change it.</i></p>

11. Fuse and main board replacement

Fuse or main board replacement is allowed to qualified personnel only. Before to operate disconnect the pump from main power and all hydraulic connections.

For fuse replacement is necessary to use a 3x16 and 3x15 screwdriver and a new fuse (same model of old one).

For main board replacement is necessary to use a 3x16 and 3x15 screwdriver and a new main board (same model of old one).

Fuse replacement procedure:

- Turn pump's injection knob on 0%.
- Remove 6 screws from pump's back.
- Pull pump's back cover until it's completely separated from pump's front. Be careful of the knob's spring.
- Locate the blown fuse and replace it.
- Reassemble the pump. Be careful to put back the knob's spring.
- Reinsert screws.

Main board replacement procedure:

- Turn pump's injection knob on 0%.
- Remove 6 screws from pump's back.
- Pull pump's back cover until it's completely separated from pump's front. Be careful of the knob's spring.
- Remove board's screws.
- Completely disconnect wires from main board and replace it. Reinsert screws.
- Reconnect wires to the main board (see enclosed picture).
- Reassemble the pump. Be careful to put back the knob's spring.
- Reinsert screws.

12. Main Board

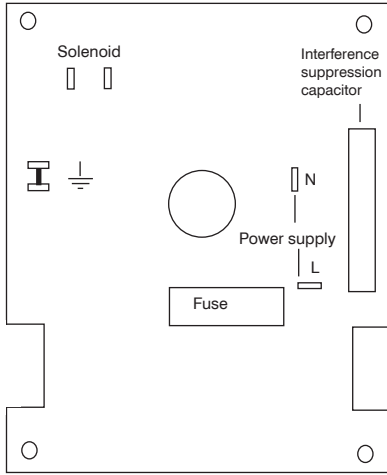

Mod. KCO

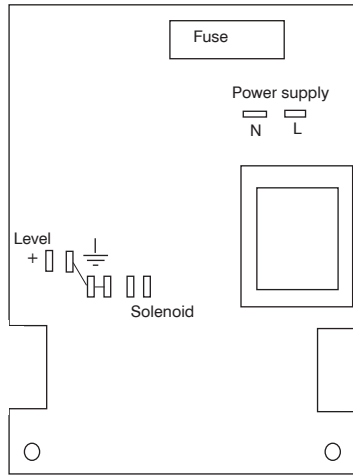

Mod. KCL

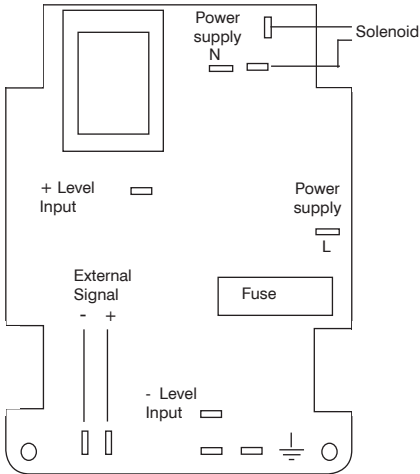

Mod. KIC / KIS

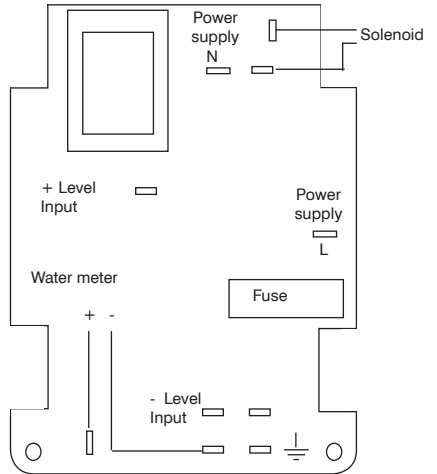

Mod. KPV / KPVM

A Appendix. Maintenance.

Maintenance schedule

! In order to ensure the requirements of potable drinking water treated and the maintenance of the improvements as declared by the manufacturer, this equipment must be checked at least once a month.

! **OPERATOR PROTECTION**

Use safety equipment according to the company regulations.

Use this safety equipment within the work area during installation, service and when handling chemicals:

- protective mask
- protective gloves
- safety goggles
- ear plugs or hear muffs
- further security device, if necessary.

! **POWER SUPPLY DISCONNECTION**

Always disconnect power to the motor before you perform any installation or maintenance tasks. Failure to disconnect power will result in serious physical injury.

! Installation and maintenance tasks should be carried out by **AUTHORIZED AND QUALIFIED PERSONNEL** only in accordance with local regulations.

i Use original spare parts.

Maintenance inspection

! **Shutdown the dosing pump before any maintenance operation**  **Shutdown procedure.**

A maintenance schedule includes these types of inspections:

- Routine maintenance and inspections
- Three-month inspections
- Annual inspections

Shorten the inspection intervals appropriately if the pumped chemical is abrasive or corrosive.

Routine maintenance and inspections

Perform these tasks whenever you perform routine maintenance:

- Inspect the seal. Ensure that there are no leaks from the mechanical seal.
- Check electrical wiring
- Check for unusual noise and vibration (noise allowed 74 dbA; \pm 5 dB).
- Check the pump and piping for leaks.
- Check for corrosion on parts of the pump and / or on hoses.

Three-month inspections

Perform these tasks every three months:

- Check that the tightenings.
- Check the mechanical seal if the pump has been left idle.

Annual inspections

Perform these inspections one time each year:

- Check the pump capacity (as per nameplate).
- Check the pump pressure (as per nameplate).
- Check the pump power (as per nameplate).

f the pump performance does not satisfy your process requirements, and the process requirements have not changed, then perform these steps:

1. Disassemble the pump.
2. Inspect it.
3. Replace worn parts.

**Shutdown
procedure**

⚠ This procedure SHOULD BE CARRIED OUT BY AUTHORIZED AND QUALIFIED PERSONNEL

⚠ OPERATOR PROTECTION

**Use safety equipment according to the company regulations.
Use this safety equipment within the work area during installation, service and when handling chemicals:**

- **protective mask**
- **protective gloves**
- **safety goggles**
- **ear plugs or hear muffs**
- **further security device, if necessary.**

Shutdown the dosing pump before any maintenance operation or before long downtimes.
Disconnect power and ensure it cannot be restarted.

⚠ Depressurize the system. The liquid may leak splashing.

Drain the chemical from pump head.
Release the pressure and disconnect the discharge pipe from the discharge valve.
Rinse the pump head and clean all valves.

B Appendix. Construction Materials and Technical info

POWER SUPPLY	FREQ.	FUSE
230 VAC (180-270 VAC)	50/60 Hz	1 A
115 VAC (90-135 VAC)	50/60 Hz	500 mA
24 VAC (20-32 VAC)	50/60 Hz	2A
12 VDC (10-16 VDC)		3.15A

Suction Height: 1,5 metres
 Environment Temperature: 0 ÷ 45°C (32 ÷ 113°F)
 Chemical Temperature: 0 ÷ 50°C (32 ÷ 122°F)
 Packaging and Transporting Temp.: -10÷+50°C (14 ÷ 122°F)

Installation Class: II
 Pollution Level: 2
 Altitude max: 2000 m

Audible Noise: K/KA: 73.4 dbA;
 K/KA silenced: 70.4 dbA;
 K/KA ultrasilenced: 69.4 dbA;
 K AC: 78.3 db(A)

Protection degree: KMS / KMSA / KMS AC: IP 65 UR working % : 85% with t ≤40 °C; 70% at 50 °C (non condensing).

ONLY FOR mod. K AC:

Air suction 6 l/h
 Suction air pressure 7 bar
 Compressed air without lubricant and/or condensed water. Air supply pressure range must be from 6 to 10 bar.

INFORMATION																
Models K	Flow				cc per stroke		Pressure		imp/min	Ampere peak (A)				Hoses	Pump head	SS pump head
	min cc/h	max l/h	Min GPH	Max GPH	Min	Max	bar	PSI		230 VAC	115 VAC	24 VAC	12 VDC			
	1802	64.80	02	0.02	0.53	0.06	0.2	18		261	180	2.7	1.45			
1504	118.80	04	0.03	1.06	0.12	0.4	15	218	180	2.7	1.45	6	6	4 x 6	L	Li
1005	151.20	05	0.04	1.32	0.15	0.5	10	145	180	2.7	1.45	6	6	4 x 6	L	Li
0808	237.60	08	0.06	2.11	0.21	0.7	08	116	180	2.7	1.45	6	6	4 x 6	L	Li
0510	302.40	10	0.08	2.64	0.27	0.9	05	73	180	2.7	1.45	6	6	4 x 6	L	Li
0501	29.16	1	0.01	0.26	0.03	0.1	5	72	180	2.7	1.45	6	6	4 x 6	I	li
0218	540.00	18	0.14	4.76	0.51	1.7	02	29	180	2.7	1.45	6	6	6 x 8	M	G
SELF VENTING MODELS																
1801	29.16	1	0.008	0.26	0.03	0.09	18	261	180	2.7	1.45	6	6	4 x 6	LA	-
1503	86.4	3	0.023	0.79	0.08	0.28	15	217	180	2.7	1.45	6	6	4 x 6	LA	-
103.5	108	3.5	0.029	0.92	0.10	0.32	10	145	180	2.7	1.45	6	6	4 x 6	LA	-
085.5	162	5.5	0.043	1.45	0.15	0.51	8	116	180	2.7	1.45	6	6	4 x 6	LA	-
057.5	226.8	7.5	0.060	1.98	0.21	0.69	5	72	180	2.7	1.45	6	6	4 x 6	LA	-
0213	399.6	13	0.106	3.43	0.37	1.20	2	29	180	2.7	1.45	6	6	6 x 8	MA	-
COMPRESSED AIR MODEL																
1018	0.6	18	0.16	4.7	0.6	2	10	145	140	0.1	0.5	0.9	-	6X8	M	-

Construction material

✓ : standard
 X: option (ask for availability)

	PVDF	PP	PPVO	PMMA	PVC	PE	CE	VETRO	PTFE	SS	VITON®	EPDM	WAX	SI
BOX		✓	X											
CORPO POMPA	✓			X										
DIAFRAMMA									✓					
BIGLIE							✓	X	X	X				
TUBO ASPIRAZIONE	X				✓	X								
TUBO MANDATA	✓				X	X								
TUBO SPURGO	X				✓	X								
O RING									X		X	X	X	X
SONDA LIVELLO/ FILTRO FONDO	✓													
CAVO SONDA LIVELLO						✓								

bar

C Appendix. Delivery Curves

Flow rate indicated is for H₂O at 20°C at the rated pressure. Dosing accuracy ± 2% at constant pressure ± 0,5 bar.

1802: l/h 2 bar 18
Corpo pompa / Pump head mod. L

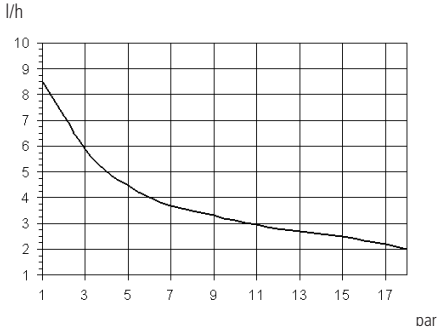

1504: l/h 4 bar 15
Corpo pompa / Pump head mod. L

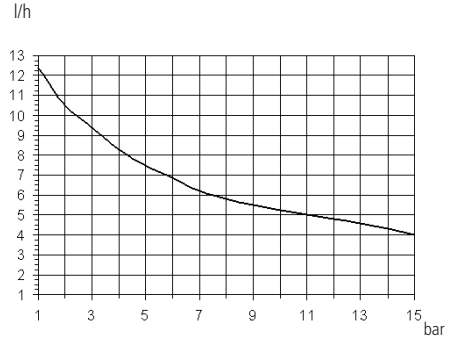

1005: l/h 5 bar 10
Corpo pompa / Pump head mod. L

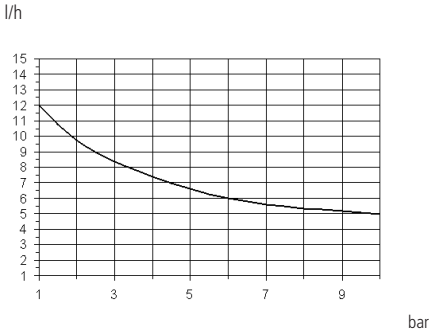

0808: l/h 8 bar 8
Corpo pompa / Pump head mod. L

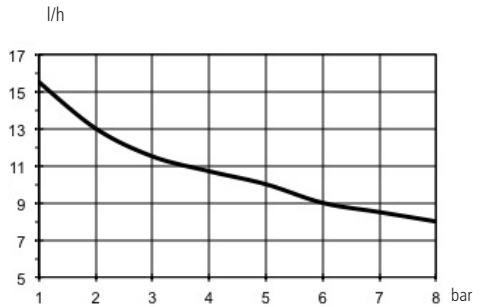

0501: l/h 1 bar 5
Corpo pompa / Pump head mod. L

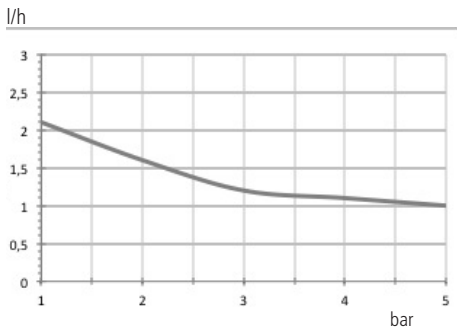

0510: l/h 10 bar 5
Corpo pompa / Pump head mod. L

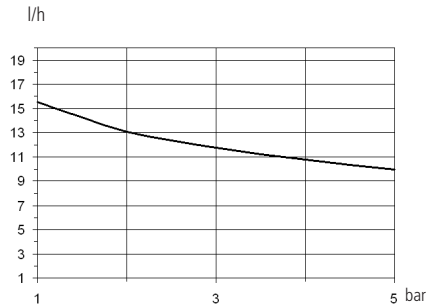

0218: l/h 18 bar 2
Corpo pompa / Pump head mod. M

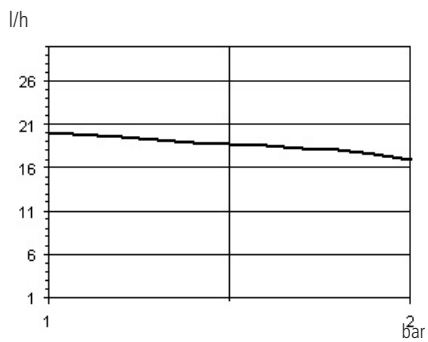

C Appendix. Delivery Curves for self-venting pump head

Flow rate indicated is for H₂O at 20°C at the rated pressure. Dosing accuracy $\pm 2\%$ at constant pressure $\pm 0,5$ bar.

1801: l/h 1 bar 18
Pump head mod. LA

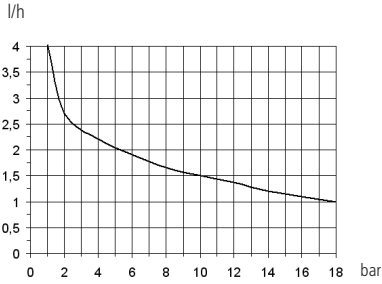

1503: l/h 3 bar 15
Pump head mod. LA

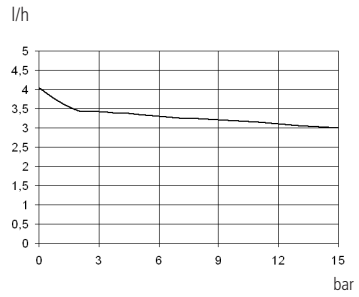

103,5: l/h 3,5 bar 10
Pump head mod. LA

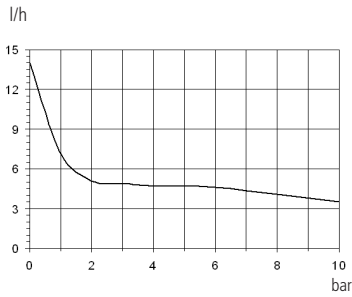

085,5: l/h 5,5 bar 8
Pump head mod. LA

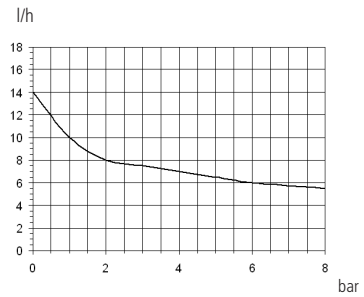

057,5,5: l/h 7,5 bar 5
Pump head mod. LA

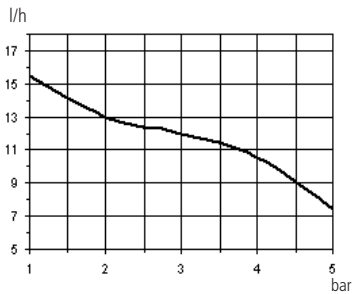

Q213: l/h 13 bar 2
Pump head mod. MA

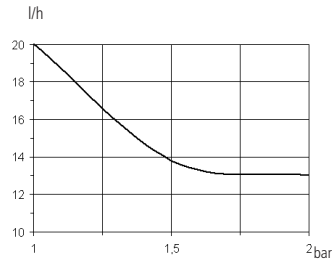

0213: l/h 13 bar 2
Pump head mod. MA

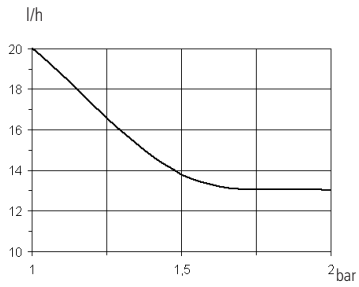

K AC SERIES

1018: l/h 18 bar 10
Corpo pompa / Pump head mod. M

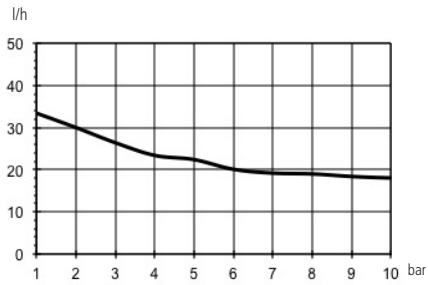

140 SPM

D Appendix. Dimensions

Dimensions

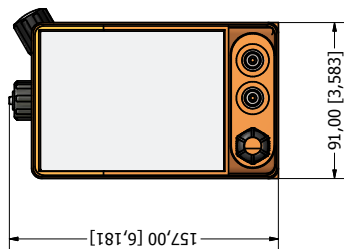
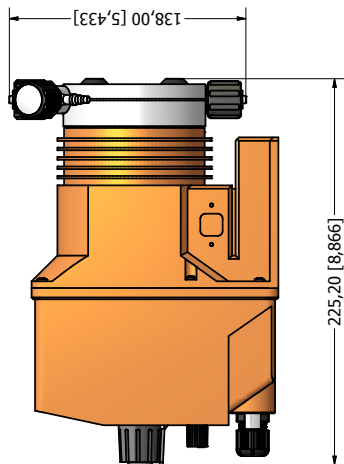
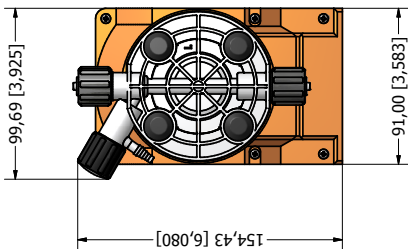
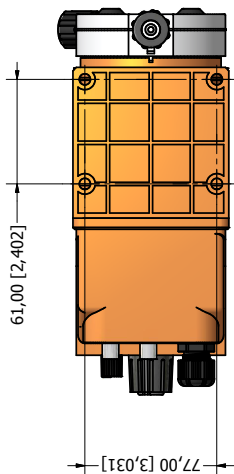

bold : mm
 () : inches

E Appendix. Chemical Compatibility Table

Solenoid driven metering pumps are widely used to dose chemical fluids and it is important that the most suitable material in contact with fluid is selected for each application. This compatibility table serves as a useful help in this respect. All the informations in this list are verified periodically and believed to be correct on the date of issuance. All the informations in this list are based on manufacturer's data and its own experience but since the resistance of any material depends by several factors this list is supplied only as an initial guide, in no way manufacturer makes warranties of any matter respect to the informations provided in this list.

Product	Formula	Ceram.	PVDF	PP	PVC	SS 316	PMMA	Hastel.	PTFE	FPM	EPDM	NBR	PE
Acetic Acid, Max 75%	CH3COOH	2	1	1	1	1	3	1	1	3	1	3	1
Hydrochloric Acid, Concentrate	HCl	1	1	1	1	3	1	1	1	1	3	3	1
Hydrofluoric Acid 40%	H2F2	3	1	3	2	3	3	2	1	1	3	3	1
Phosphoric Acid, 50%	H3PO4	1	1	1	1	2	1	1	1	1	1	3	1
Nitric Acid, 65%	HNO3	1	1	2	3	2	3	1	1	1	3	3	2
Sulphuric Acid, 85%	H2SO4	1	1	1	1	2	3	1	1	1	3	3	1
Sulphuric Acid, 98.5%	H2SO4	1	1	3	3	3	3	1	1	1	3	3	3
Amines	R-NH2	1	2	1	3	1	-	1	1	3	3	1	1
Sodium Bisulphite	NaHSO3	1	1	1	1	2	1	1	1	1	1	1	1
Sodium Carbonate (Soda)	Na2CO3	2	3	1	1	1	1	1	1	2	1	1	1
Ferric Chloride	FeCl3	1	1	1	1	3	1	1	1	1	1	1	1
Calcium Hydroxide (Slaked Lime)	Ca(OH)2	1	1	1	1	1	1	1	1	1	1	1	1
Sodium Hydroxide (Caustic Soda)	NaOH	2	1	1	1	1	1	1	1	2	1	2	1
Calcium Hypochlor.(Chlor.ted Lime) ¹	Ca(OCl)2	1	1	1	1	3	1	1	1	1	1	3	1
Sodium Hypochlorite, 12.5%	NaOCl + NaCl	1	1	2	1	3	1	1	1	1	1	2	3
Potassium Permanganate, 10%	KMnO4	1	1	1	1	1	1	1	1	1	1	3	1
Hydrogen Peroxide, 30% (Perydrol)	H2O2	1	1	1	1	1	3	1	1	1	3	3	1
Aluminium Sulphate	Al2(SO4)3	1	1	1	1	1	1	1	1	1	1	1	1
Copper-II-Sulphate (Roman Vitriol)	CuSO4	1	1	1	1	1	1	1	1	1	1	1	1

¹ Calcium Hypochlor.(Chlor.ted Lime): WQA test was based on 1% Calcium Hypochlorite solution.

Resistance rating

Resistant	1
Fairly resistant	2
Not resistant	3

MATERIALS

Polyvinylidene fluoride	PVDF	Pump Heads, valves, fitting, tubing
Polypropylene	PP	Pump Heads, valves, fitting, level floater
PVC	PVC	Pump Heads
Stainless steel	SS 316	Pump Heads, valves
Polymethyl Metacr.(Acrylic)	PMMA	Pump Heads
Hastelloy	C-276	Injection valve spring
Polytetrafluoroethylene	PTFE	Diaphragm
Fluorocarbon (Viton® B)	FPM	Sealings
Ethylene propylene	EPDM	Sealings
Nitrile	NBR	Sealings
Polyethylene	PE	Tubing

F Appendix. Hoses resistance table

Hose features are very important for a reliable dosage. Every pump's model is made to work in the best way using selected hoses according to pump's capacity / model. Information reported here are intended for standard use only. For extended information ask to hose's manufacturer.

Suction / Delivery Hose			
4x6 mm PVC (transparent)	4x8 mm PE (opaque)	6x8 mm PE (opaque)	8x12 mm PVC (transparent)

Delivery Hose	Working Pressure				Breaking Pressure			
4x6 mm PE 230 (opaque)	20°C 12 bar	30°C 10.5 bar	40°C 8.5 bar	50°C 6.2 bar	20°C 36 bar	30°C 31.5 bar	40°C 25.5 bar	50°C 18.5 bar
4x8 mm PE 230 (opaque)	20°C 19 bar	30°C 15.7 bar	40°C 12 bar	50°C 7.5 bar	20°C 57 bar	30°C 47 bar	40°C 36 bar	50°C 22.5 bar
6x8 mm PE 230 (opaque)	20°C 8.6 bar	30°C 6.8 bar	40°C 4.8 bar	50°C 2.3 bar	20°C 26 bar	30°C 20.5 bar	40°C 14.5 bar	50°C 7 bar
8x12 mm PE 230 (opaque)	20°C 12 bar	30°C 10.5 bar	40°C 8.5 bar	50°C 6.2 bar	20°C 36 bar	30°C 31.5 bar	40°C 25.5 bar	50°C 18.5 bar
4x6 mm PVDF Flex 2800 (opaque)	20°C 40 bar	30°C 34 bar	40°C 30 bar	50°C 27 bar	60°C 24.8 bar	80°C 20 bar	90°C 10 bar	
6x8 mm PVDF Flex 2800 (opaque)	20°C 29 bar	30°C 25.5 bar	40°C 22 bar	50°C 20 bar	60°C 18 bar	80°C 14.5 bar	90°C 7.3 bar	
8X10 mm PVDF Flex 2800 (opaque)	20°C 18 bar	30°C 15.5 bar	40°C 13.5 bar	50°C 12.5 bar	60°C 11.2 bar	80°C 9 bar	90°C 4.5 bar	
1/4 PE 230 (opaque)	20°C 17.6 bar							
3/8 PE 230 (opaque)	20°C 10.6 bar							
1/2 PE 230 (opaque)	20°C 10.6 bar							

G Appendix. "KCL" Installation drawing

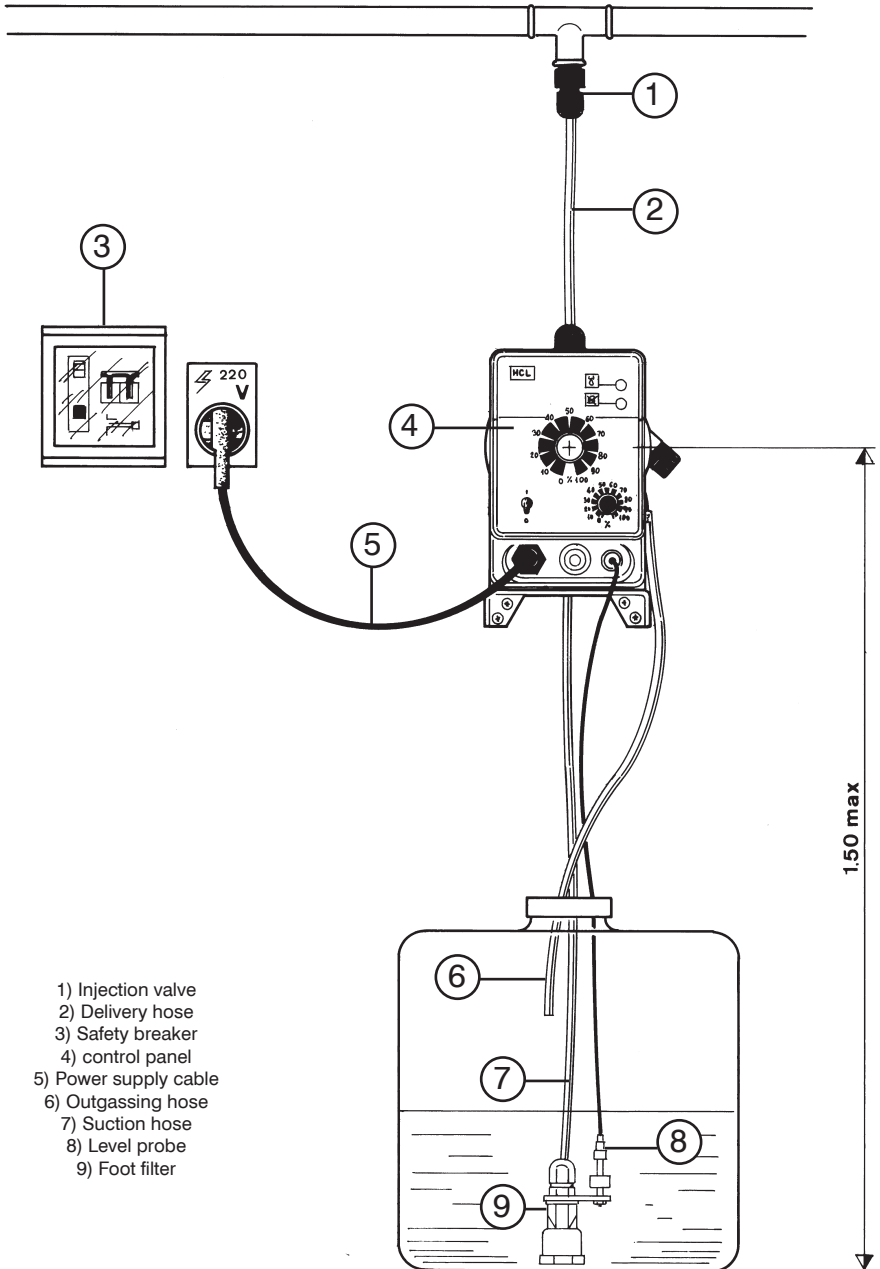

G Appendix. "KCO" Installation drawing

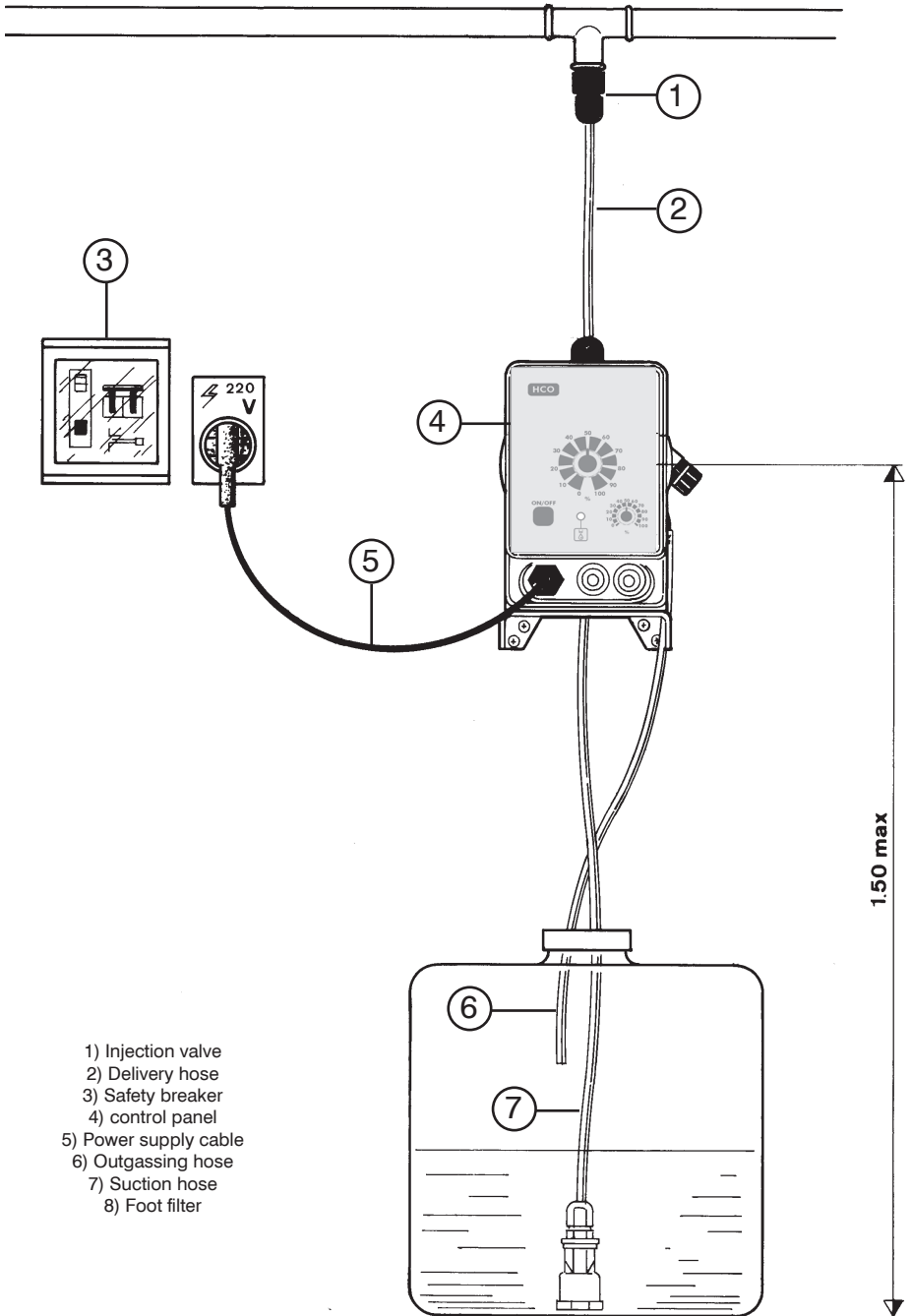

- 1) Injection valve
- 2) Delivery hose
- 3) Safety breaker
- 4) control panel
- 5) Power supply cable
- 6) Outgassing hose
- 7) Suction hose
- 8) Foot filter

G Appendix. "KIC" Installation drawing

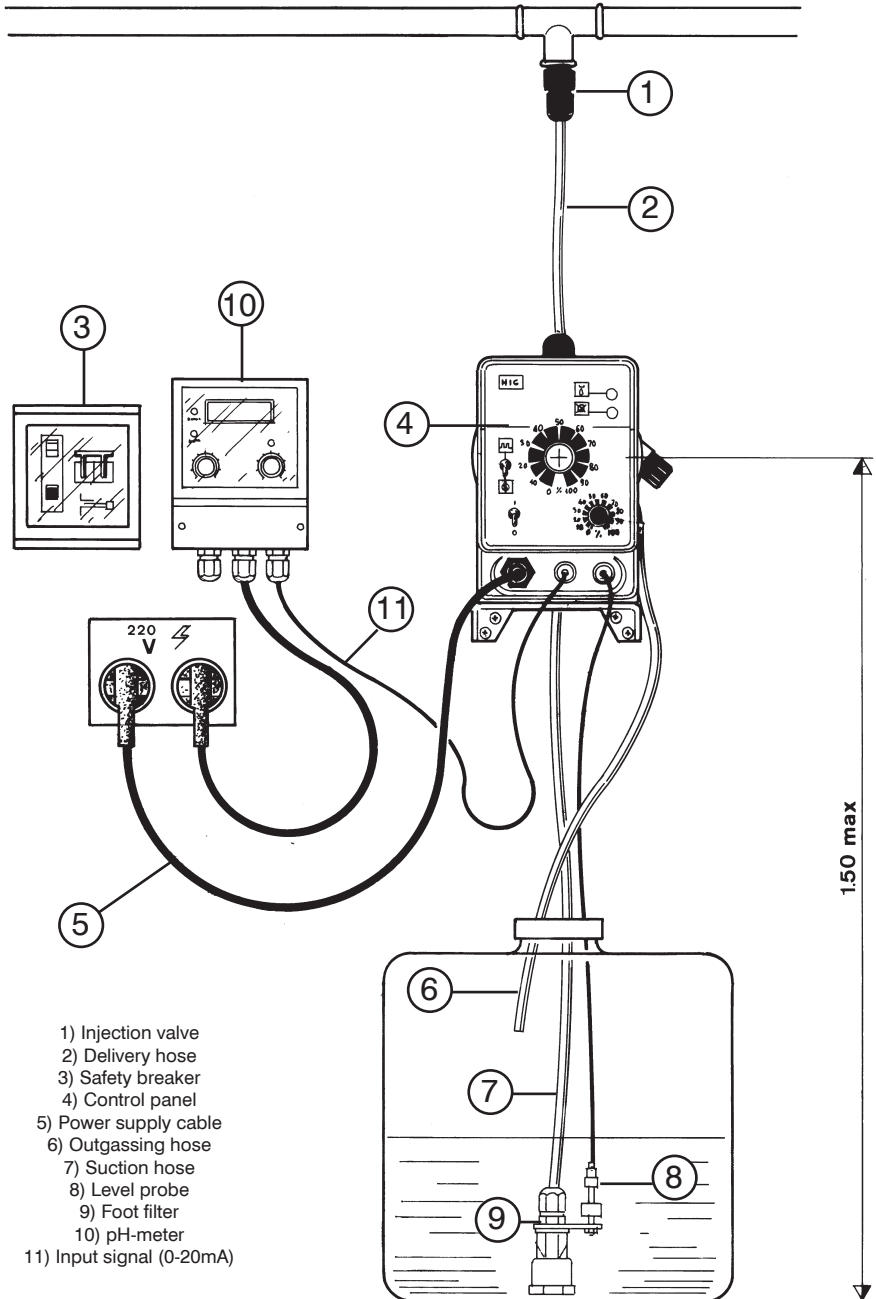

G Appendix. "KPV" Installation drawing

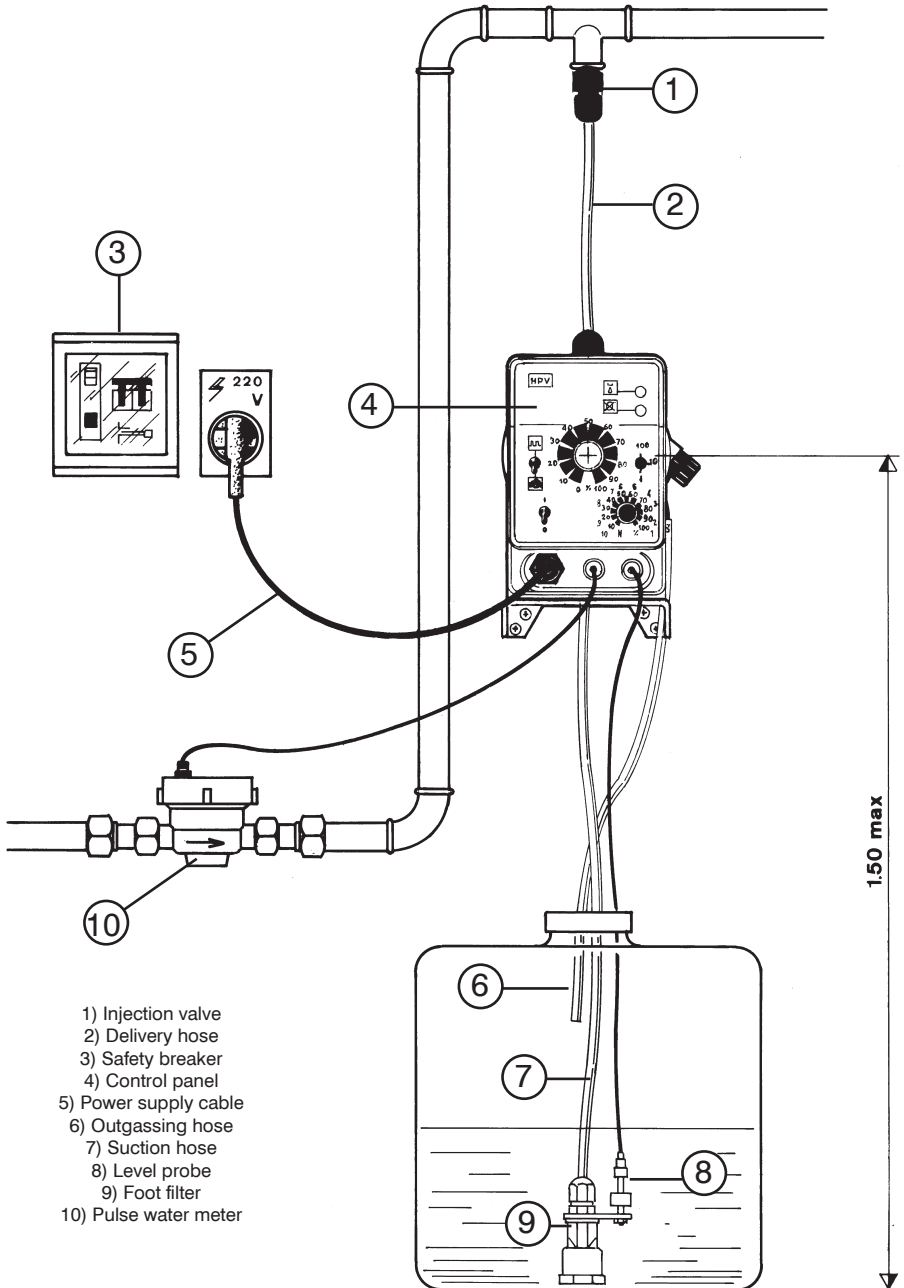

G appendix. "KIS" Installation drawing

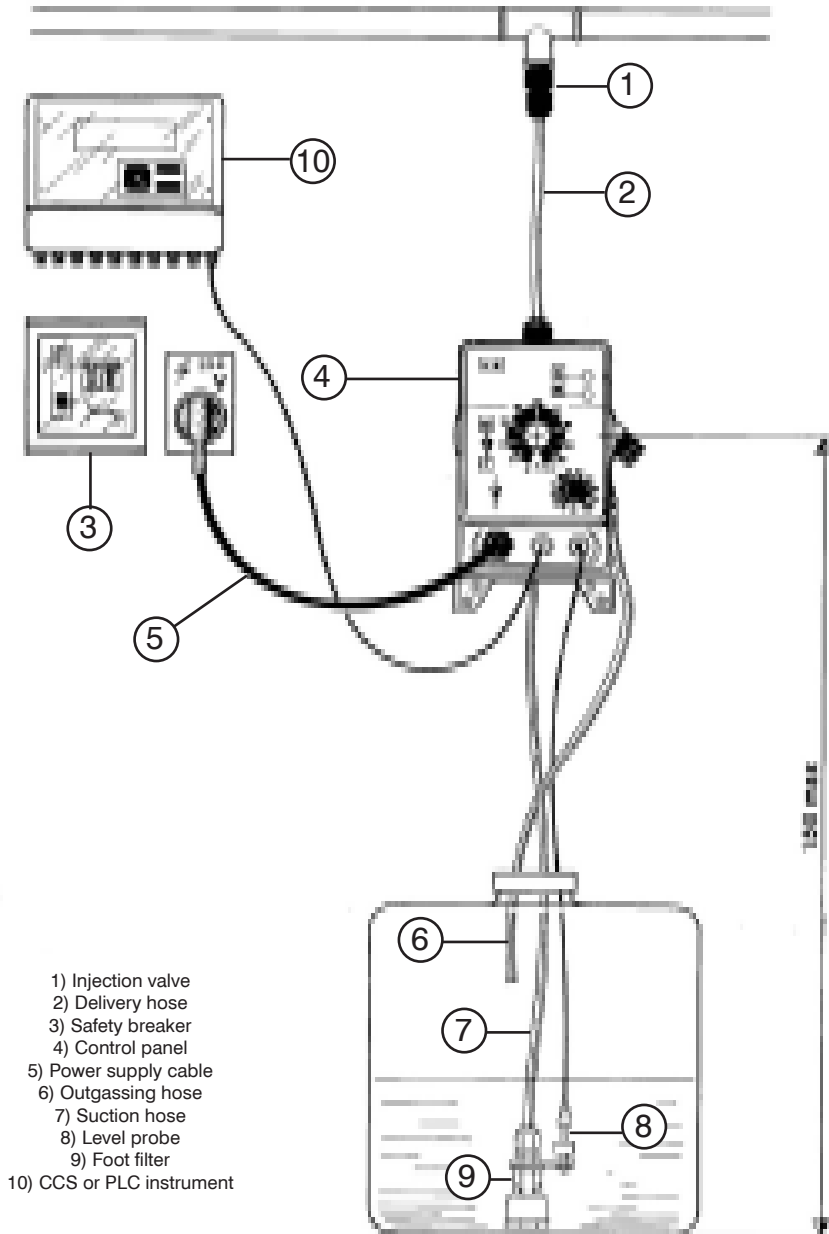

H appendix. Exploded view

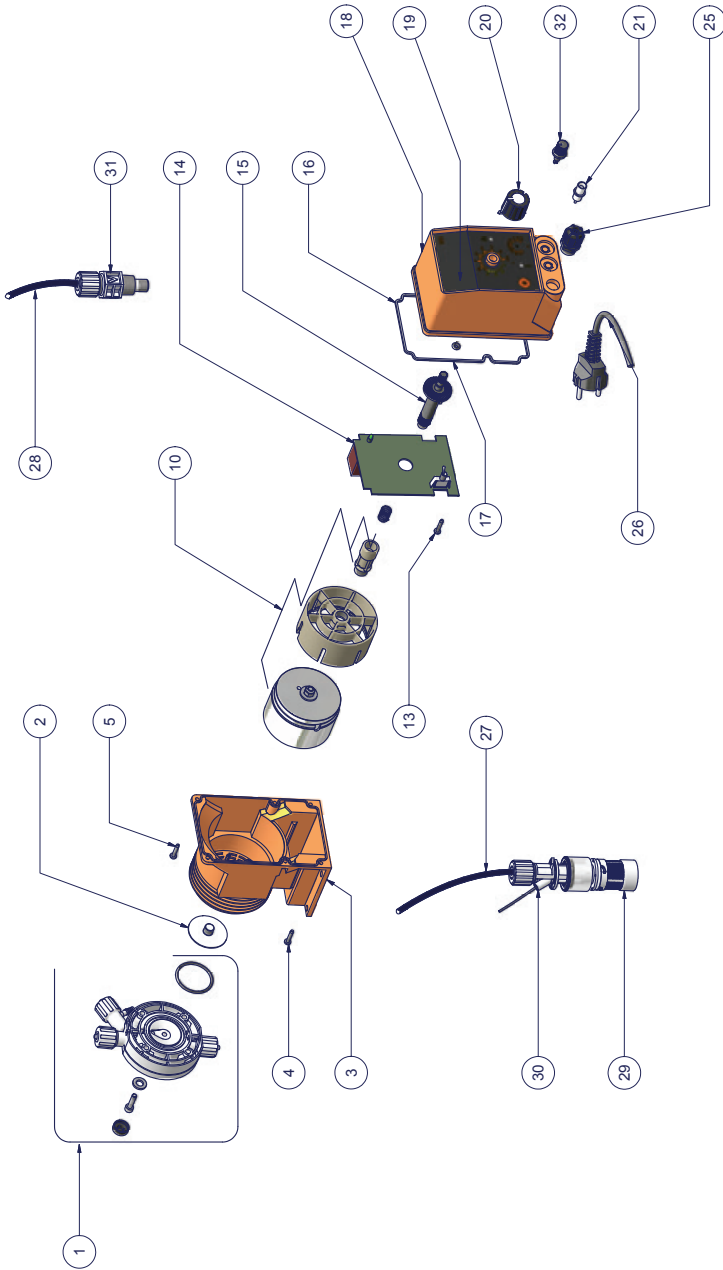

NOTICE: always specify the pump's label when ordering spare parts.

PRODUCT SERVICE REPAIR FORM

ENCLOSE THE PRESENT FORM TO THE DELIVERY NOTE

DATE

SENDER
 Company name.....
 Address

Phone no.
 Contact person.....

PRODUCT TYPE (see product label)

DEVICE CODE
S/N (serial number).....

OPERATING CONDITIONS

Location/installation description

Chemical

Start-up (date) Running time (approx. hours).....

REMOVE ALL THE LIQUID INTO THE PUMP HEAD AND DRY IT BEFORE PACKAGING IN ITS ORIGINAL BOX.

DESCRIPTION OF PROBLEM

- MECHANICAL
 - Wear parts.....
 - Brekage/other damages
 - Corrosion.....
 - Other.....
- ELECTRICAL
 - Connections, connector, cables
 - Operating controls (keyboard, display, etc.)
 - Elettronics.....
 - Other.....
- LEAKS
 - Connections.....
 - Pump head
- NOT OR INADEQUATE FUNCTION/OTHER
 -
 -
 -

I declare that the dosing pump is free of any hazardous chemical.

Summary

GENERAL SAFETY GUIDELINES.....	2
Purpose of use AND SAFETY	3
Environmental safety	4
LABEL	4
Spare parts.....	4
Transportation and storage.....	5
1. Introduction	6
2. Unpacking.....	7
3. Pump's description	8
4. Before to Install warnings	9
5. Installation Draw	10
6. Hydraulic Installation	11
6. Hydraulic Installation	12
6. Hydraulic Installation	13
6. Hydraulic Installation	14
7. Electrical Installation.....	15
7. Electrical Installation.....	16
8. Models.....	17
9. Priming	25
10. Troubleshooting.....	26
11. Fuse and main board replacement	27
12. Main Board	28
A Appendix. Maintenance	29
C Appendix. Delivery Curves	33
C Appendix. Delivery Curves for self-venting pump head	35
D Appendix. Dimensions.....	37
E Appendix. Chemical Compatibility Table	38
F Appendix. Hoses resistance table	39
G Appendix. "KCL" Installation drawing	40
G Appendix. "KCO" Installation drawing.....	41
G Appendix. "KIC" Installation drawing	42
G Appendix. "KPV" Installation drawing	43
G appendix. "KIS" Installation drawing.....	44
H appendix. Exploded view.....	45



*When dismantling a pump please separate material types and send them according to local recycling disposal requirements.
We appreciate your efforts in supporting your local Recycle Environmental Program.
Working together we'll form an active union to assure the world's invaluable resources are conserved.*