



This manual contains safety information that if ignored can endanger life or result in serious injury. They are indicated by this icon.



Keep the instrument protected from sun and water. Avoid water splashes.



OPERATING INSTRUCTIONS FOR "LDPHCL" INSTRUMENT SERIES

with data logger software quick guide



ERMES COMMUNICATION
www.ermes-server.com



Read Carefully !



ENGLISH Version

R10-06-14



NORME CE
EC RULES(STANDARD EC)
NORMAS DE LA CE

Direttiva Bassa Tensione
Low Voltage Directive
Directiva de baja tensión } 2014/35/UE

Direttiva EMC Compatibilità Elettromagnetica
EMC electromagnetic compatibility directive
EMC directiva de compatibilidad electromagnética } 2014/30/UE



GENERAL SAFETY GUIDELINES

Danger!

In emergencies the instrument should be switched off immediately! Disconnect the power cable from the power supply!

When installing always observe local regulations!

Manufacturer is not liable for any unauthorized use or misuse of this product that may cause injury, damage to persons and / or materials.

Caution!

Instrument must be accessible at all times for both operating and servicing. Access must not be obstructed in any way!

Feeder should be interlocked with a no-flow protection device to automatically shut-off the pumps when there is no flow

Pumps and accessories must be serviced and repaired by qualified and authorized personnel only

Always discharge the liquid end before servicing the instrument!

Empty and rinse the liquid end before work on a pump which has been used with hazardous or unknown chemicals!

Always read chemical safety datasheet!

Always wear protective clothing when handling hazardous or unknown chemicals!

Instrument must be operated / serviced by trained technicians only!

All connection operations must be performed while the instrument is not connected to main supply!

1. Introduction

LDPHCL is a microprocessor based digital regulator for pH and Chlorine with temperature reading. On/Off, impulsive proportional, proportional PWM or fixed PWM are main working modes. Pulses per minute can be set for outputs. Working ranges are: pH : from 0 to 14pH - Chlorine: from 0 to 10 mg/l. All information are provided through a large LCD display. Using a revolutionary wheel control the instrument can be easily programmed. LDPHCL is housed in a IP65 plastic box.

INPUTS:

- Stand-by
- Flow
- pH (+) level
- pH (-) level
- Chlorine level
- pH probe
- Chlorine probe
- Temperature probe

OUTPUTS:

- 2 relay outputs (pH and Cl)
- 3 opto coupled pulses outputs (pH and Cl)
- 1 Main alarm
- 1 Flocculant

2. The wheel

Located in the upper right side of LDPHCL there is a wheel that must be used to control the instrument. Wheel can be rotated in both directions to scroll over the menus and / or pressed to confirm highlighted selection / alue.

NOTE: Once changes are made press "OK" to save and exit from submenu. Press "ESC" to exit without saving.

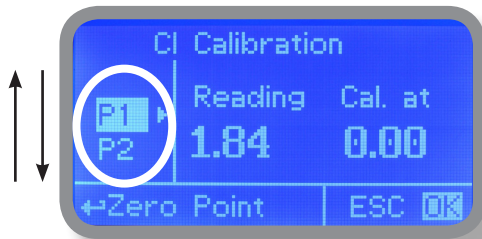

Rotate wheel to scroll through menus or options

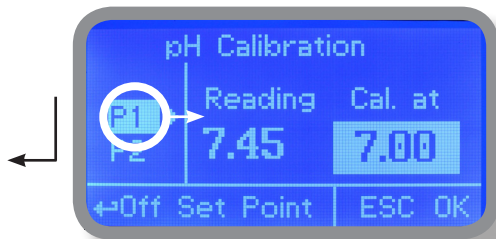

Press wheel to select highlighted option

3. Mainboard Connections

Unplug instrument from main power supply then perform connections by following the above picture.

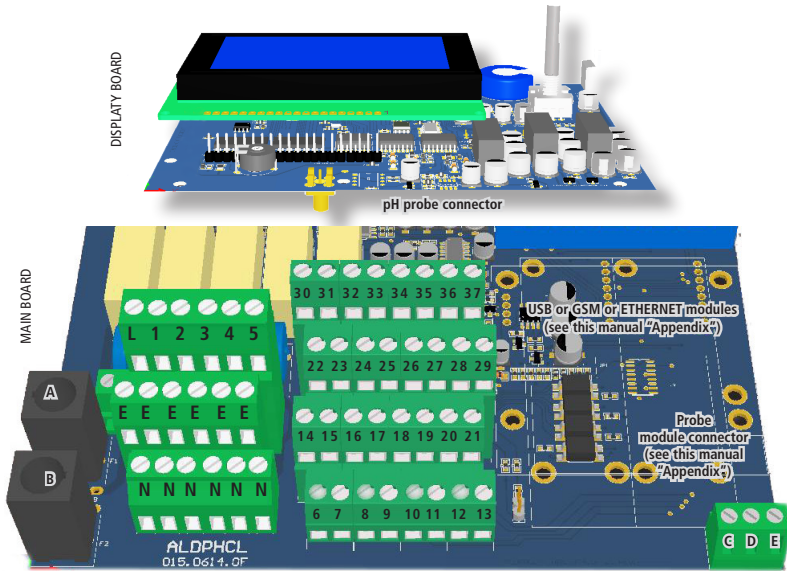

A: Main Fuse (6A T)

B: Instrument Fuse (3.15A T)

L(Live) - E (Earth) - N (Neutral); 85÷264VAC - 50/60 Hz

1(Live) - E(Earth) - N(Neutral): 85÷264VAC - 5A 50/60 Hz Relay 1 Output "CH1 PH RELAY". To use with ON/OFF or PWM device

2(Live) - E(Earth) - N(Neutral): 85÷264VAC - 5A 50/60 Hz Relay 2 Output "CH2 CL2 RELAY". To use with ON/OFF or PWM device

3(Live) - E(Earth) - N(Neutral) : 85÷264VAC Alarm output

4(Live) - E(Earth) - N(Neutral) : 85÷264VAC Flocculant output (always enabled except when Standby or Flow alarm)

31(-) - 30(+): Current output mA1 for pH

31(-) - 32(+): Current output mA2 for Cl

34(-) - 33(+): Current output mA3

34(-) - 35(+): Current output mA4 for temperature

Max resistive load: 500 Ohm

22(-) - 23(+): Output "CH1 PH PULSE 2" (with photocoupler). For dosing pumps "IS" o "MF" series

24(-) - 25(+): Output "CH2 CL2 PULSE" (with photocoupler). For dosing pumps "IS" o "MF" series

26(-) - 27(+): Output "CH1 PH PULSE 1" (with photocoupler). For dosing pumps "IS" o "MF" series

21(GND) - 28(+RS485) - 29(-RS485): RS485 (no MODBUS)

14(+ Brown) - 15(Black) - 16/17(- Blue ; GND): Proximity sensor mod. "SEPR"

11(-) - 10(+): Standby contact

11(-) - 12(+): Chlorine Level contact

19(-) - 18(+): pH Level 1 contact

19(-) - 20(+): pH Level 2 contact

6(Green) - 7(Brown) - 8(White) - 9(Yellow): PT100 temperature probe (remove resistance prior to install probe)

Warning: Connections must be performed by qualified and trained personnel onl .

4. Main Screen

When into normal operating mode, LDPHCL shows the following main screen:

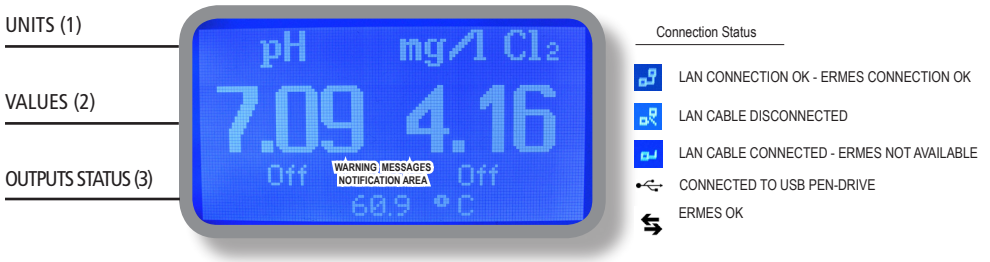

Main screen zones:

(1) UNITS

"pH" is the measuring unit for pH probe.
 "mg/l" is the measuring unit for Chlorine probe.

(2) VALUES

These numbers are values read by the probes.

(3) OUTPUTS STATUS

These fields are related to current outputs status and instrument activity. For more information rotate the wheel when into main screen. (see next page)

During critical situations a warning / alarm message may appear. To in-depth explanation **completely rotate clockwise** the wheel to review main instrument parameters and current outputs status.

WARNING MESSAGE NOTIFICATION AREA

WHEN AN ALARM OCCURS (flow, level, dosage, faulty probe, setpoint) and "ALARM" appears on main screen all outputs are disabled.

Warning:

If SCL probe has been disconnected from controller / not found then "PROBE n/a" message will appear on display and related outputs will be disabled!

Note: the word "PUMP" as shown into this manual refers to a "dosing device" connected to the instrument!

5. Quick status check

From main screen **completely rotate clockwise** the wheel to review main instrument parameters and current outputs status.



Local Time
Local Date
pH probe reading
Chlorine probe reading

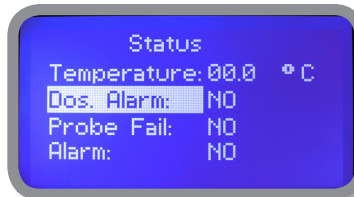

Temperature probe reading
Dosing alarm condition
Probe failure status
Alarm contact status

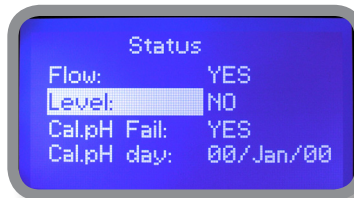

Flow contact status (SEPR)
Tank Level 1 status
Last pH calibration result
Last pH calibration date

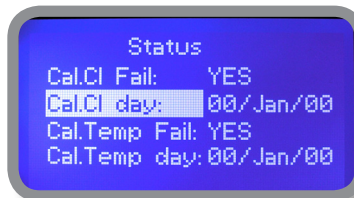

Last Chlorine calibration result
Last Chlorine calibration date
Last Temp. calibration result
Last Temp. calibration date

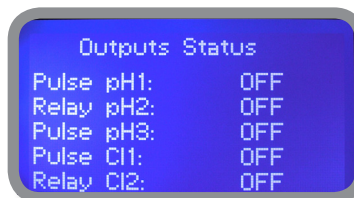

Outputs Status
See mainboard (page 4) for related connections.

6. Password

To grant access into "Main Menu" press the wheel from main screen and enter the passcode.

If this is the first time here then the passcode is 0000 (factory preset) Press wheel 5 times to enter into "Main Menu".

Otherwise press the wheel 1 time and enter the passcode. Numbers can be selected rotating the wheel.

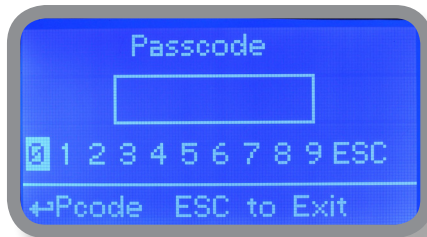
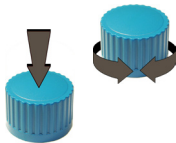
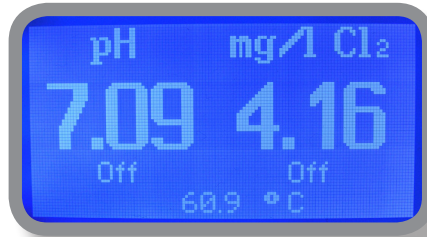

To set a new passcode choose "PARAMETERS" from "Main Menu", move on "New Pcode", click on wheel and enter a four numbers code. Click on "EXIT" and choose "YES" to save request. The new passcode is now ready.

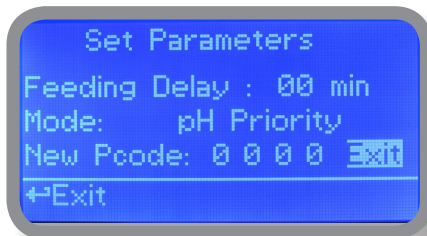
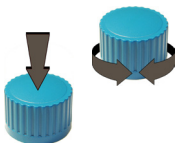

Lost passcode ?

Please don't forget the passcode (if changed). In the unfortunate event, please call your local distributor for unlocking procedure. There is no way for you to recover lost passcode.

7. "Main Menu" list

To grant access into "Main Menu" enter the passcode (as described in previous chapter). Once into "Main Menu" rotate the wheel to scroll through all the options available.



*This menu is available on ECL1 and ECL6 probe modules only
***This menu is available on current outputs instrument version only

8. "Set-Point", pH working modes

For "CH1 PH PULSE 1" and "CH1 PH PULSE 2" outputs, setpoint can be set between **On/Off mode, Proportional (%) mode or disabled (OFF)**.

For "CH1 PH RELAY" output, setpoint can be set using **On/Off mode, Proportional PWM mode, Fixed PWM mode or disabled (OFF)**.

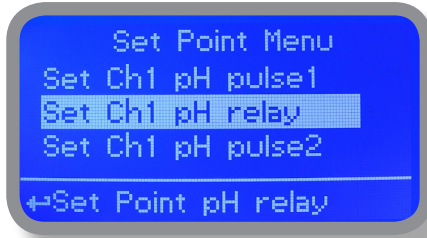

8.1 "Set-Point", pH (on/off)

This mode is valid for all pH related outputs. On/Off mode set the instrument to operate using two set values that enable or disable the pH pump. To use this mode move cursor on "Working Mode". Press the wheel and select it.

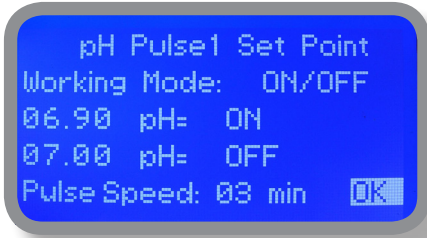
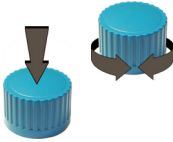

ON/OFF mode while dosing ALKALI

Set pH value at 7.00 OFF and 6.90 ON. Set Pulse Speed per minute (strokes per minute) based on dosing device capabilities.

Instrument will leave the pH pump active until reading value will increase up to 7.00pH. At 7.00pH the pH pump will be disabled until reading value will decrease under 6.90pH.

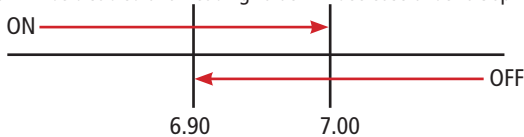

Pulse speed: to let pump operate at pulses per minutes add one or more minute (1pulse every xx minutes).

8.2 "Set-Point", pH (on/off)

This mode is valid for all pH related outputs. ON/OFF mode while dosing ACID

Set pH value at 7.00 OFF and 7.10 ON. Set Pulse Speed per minute (strokes per minute) based on dosing device capabilities.

Instrument will leave the pH pump active until reading value will decrease up to 7.00pH

At 7.00pH the pH pump will be disabled until reading value will increase up to 7.10pH.

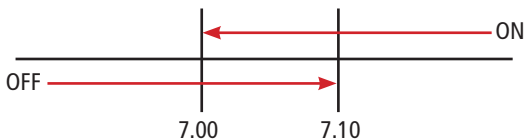

To end procedure move cursor on "OK" and press wheel to proceed to "Save" request screen. Move wheel on "YES" to save or "NO" to discard changes.

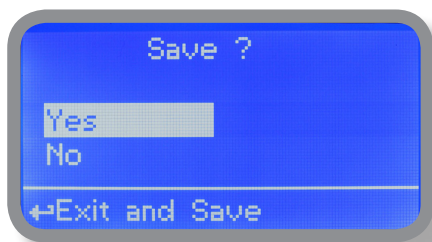

Did you know ?

In chemistry, an alkali is a basic, ionic salt of an alkali metal or alkaline earth metal element. Alkalis are best known for being bases (compounds with pH greater than 7) that dissolve in water. The adjective alkaline is commonly used in English as a synonym for base, especially for soluble bases. This broad use of the term is likely to have come about because alkalis were the first bases known to obey the Arrhenius definition of a base and are still among the more common bases. Since Brønsted-Lowry acid-base theory, the term alkali in chemistry is normally restricted to those salts containing alkali and alkaline earth metal elements.

An acid (often represented by the generic formula HA [H+A-]) is traditionally considered any chemical compound that, when dissolved in water, gives a solution with a hydrogen ion activity greater than in pure water, i.e. a pH less than 7.0. That approximates the modern definition of Johannes Nicolaus Brønsted and Martin Lowry, who independently defined an acid as a compound which donates a hydrogen ion (H+) to another compound (called a base). Common examples include acetic acid (in vinegar) and sulfuric acid (used in car batteries). Acid/base systems are different from redox reactions in that there is no change in oxidation state.

8.3 "Set-Point", pH (proportional)

This mode is valid for "CH1 PH PULSE 1" and "CH1 PH PULSE 2" outputs.

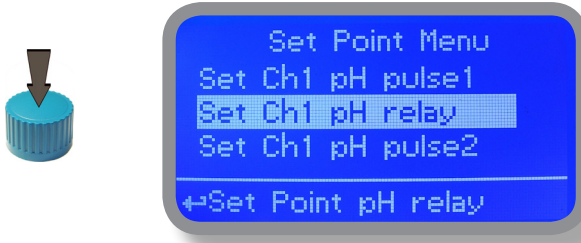

Proportional mode set the instrument to operate using a calculated percentage between two set values that enable or disable the pH pump. To use this mode move cursor on "Working Mode". Press the wheel and select it.

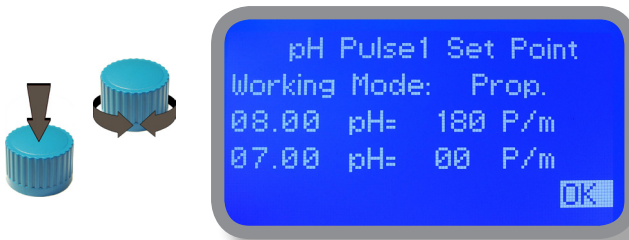

PROPORTIONAL mode between 7pH(0 P/m) and 8pH (180 P/m). p/m is : pulses per minute

In this mode the pH pump will be "ON" for values greater than 8pH with maximum set pulses per minute capacity (e.g.: 180) and it'll be "OFF" for values lower than 7pH. For values of 7.5pH pump will be "ON" with 90 pulses per minute capacity. The calculation is based on 180 pulses per minute setting (see page 22). To end procedure move cursor on "OK" and press wheel to proceed to "Save" request screen. Move wheel on "YES" to save or "NO" to discard changes.

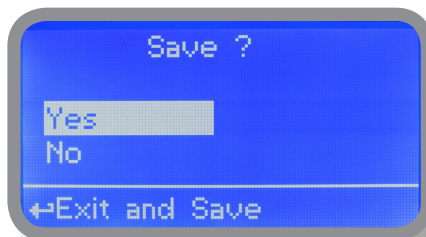

8.4 "PWM" (proportional), pH

This mode is valid for "CH1 PH RELAY" output only. Pulse-width modulation (PWM) of a signal or power source involves the modulation of its duty cycle, to either convey information over a communications channel or control the amount of power sent to a load.

This mode works over a settable (0 to 100 seconds) time to switch on or off selected output. During this time if reading value will move towards a set value (on or off) the PWM will operate the output on timered basis. Reaching the set value the PWM will permanently leave on or off the output.

Parameters to set for this mode are:

Unit Value + %: (time activity towards set value. 0% means 0 seconds. 100% means 100 seconds.)
pH range: two pH values within PWM operates.

For example: set first pH value at 8.00 = 100% and second pH value at 4.0 = 0%.
For reading values ≥ 8.00 the output will be permanently ON.
For reading values ≤ 4.0 the output will be permanently OFF.

For reading value of 7.00 the output will be OFF for 25 seconds, ON for 75 seconds.
For reading value of 6.00 the output will be OFF for 50 seconds, ON for 50 seconds.

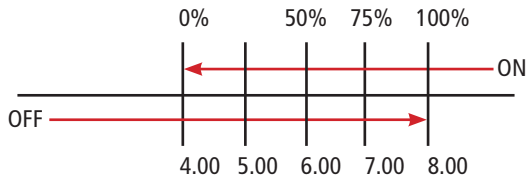
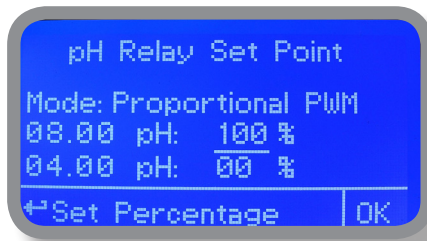

8.5 "PWM" (fixed) pH

This mode is valid for "CH1 PH RELAY" output only. Pulse-width modulation (PWM) of a signal or power source involves the modulation of its duty cycle, to either convey information over a communications channel or control the amount of power sent to a load. Using fixed mode is possible to set operating time to switch on or off selected output.

During this time if reading value will move towards a set value (on or off) the PWM will operate the output on timered basis. Reaching the set value the PWM will permanently leave on (for selected amount of time) or off the output.

Parameters to set for this mode are:

pH range: two pH values within PWM operates.

Ton: ON period, during output activity.

Toff: OFF period, during output activity.

For example: set first pH value (OFF) at 7.20.. Set second pH value (ON) at 8.00.

Set "working-pause" output activity with Toff 0 seconds and Ton 40 seconds.

For reading values \geq to 8.00 the output will be ON with activity based on Ton and Toff.

For reading values \leq 7.20 the output will be permanently OFF.

For reading values within working range operating mode is on HYSTERESIS base. Once reading value is 7.20 pH will be permanently off until it will reaches 8.00 pH.

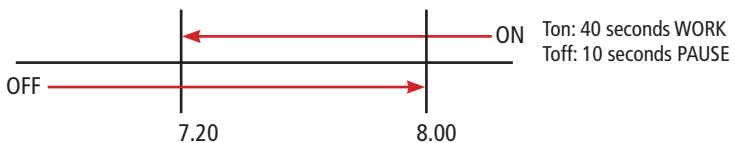
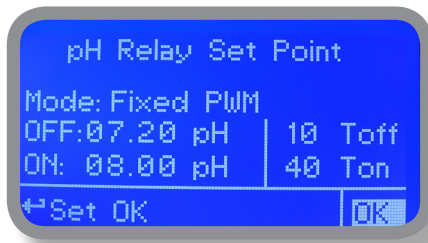

8.6 "Set-Point", CI working modes

For "CH2 CL2 PULSE", output, setpoint can be set using **On/Off mode**, **Proportional (%) mode** or **disabled (OFF)**.
For "CH2 CL2 RELAY" output, setpoint can be set using **On/Off mode**, **Proportional PWM mode**, **Fixed PWM mode** or **disabled (OFF)**.



8.7 "Set-Point", CI (on/off)

This mode is valid for all CI related outputs.

On/Off mode set the instrument to operate using two set values that enable or disable the Chlorine pump. To use this mode move cursor on "Working Mode". Press the wheel and select it.

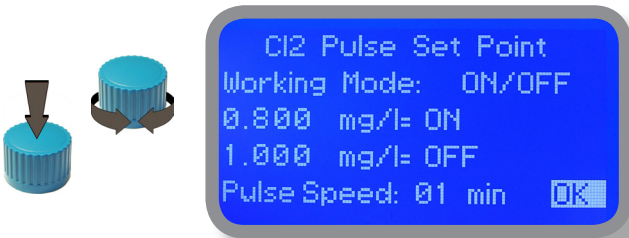

ON/OFF mode

Set CI value at 0.80 mg/l ON and 1.00 mg/l OFF. The difference between the two CI values is called HYSTERESIS. Instrument will enable the Chlorine pump when reading value will decrease at 0.80mg/l. At 0.80mg/l the Chlorine pump will be enabled until reading value will increase at 1.00mg/l.

Pulse speed: to let pump operate at pulses per minutes add one or more minute (1pulse every xx minutes).

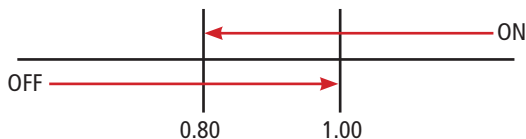

8.8 "Set-Point", Cl (proportional)

This mode is valid for "CH2 CL2 PULSE". output only.



Proportional mode set the instrument to operate using a calculated percentage between two set values that enable or disable the Chlorine pump. To use this mode move cursor on "Working Mode". Press the wheel and select it.

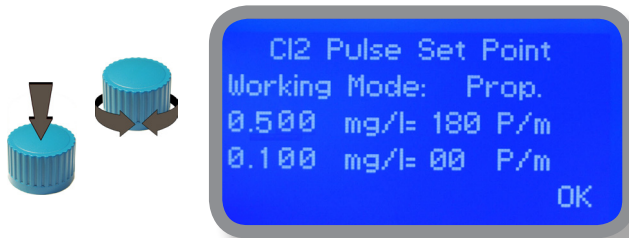

PROPORTIONAL mode between 1.00Cl (0 p/m) and 0.50Cl(180 p/m). p/m is : pulses per minute

In this mode the Cl pump will be "ON" for values lower than 0.50mg/l with set pulses/minute capacity (e.g.: 180) and it'll be "OFF" for values greater than 1mg/l. For values of 0.75mg/l pump will be "ON" with 90 p/m capacity. The calculation is based on 180 pulse / minute. To end procedure move cursor on "OK" and press wheel to proceed to "Save" request screen. Move wheel on "YES" to save or "NO" to discard changes.

To end procedure move cursor on "OK" and press wheel to proceed to "Save" request screen. Move wheel on "YES" to save or "NO" to discard changes.

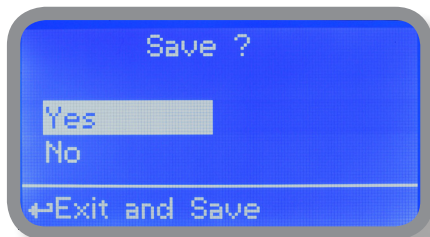

8.9 "PWM" (proportional), CI

This mode is valid for "CH2 CL2 RELAY" output only. Pulse-width modulation (PWM) of a signal or power source involves the modulation of its duty cycle, to either convey information over a communications channel or control the amount of power sent to a load.

This mode works over a settable (0 to 100 seconds) time to switch on or off selected output. During this time if reading value will move towards a set value (on or off) the PWM will operate the output on timered basis. Reaching the set value the PWM will permanently leave on or off the output.

Parameters to set for this mode are:

Unit Value + %: (time activity towards set value. 0% means 0 seconds. 100% means 100 seconds.)
CI range: two CI values within PWM operates.

For example: set first CI alue at 1.40 = 00% and second CI value at 0.80 = 60%.

For reading values \geq to 1.40 the output will be permanently OFF.

For reading values \leq 0.80 the output will be ON for 60 seconds and OFF for 40 seconds.

If reading value is 1.1 mg/l then the output will be active at 30% (ON for 30 seconds, OFF for 70 seconds).

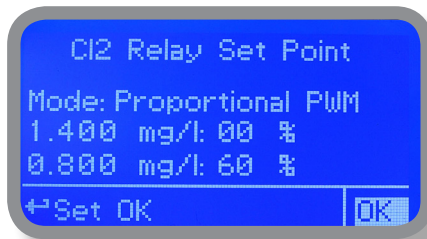

8.10 "PWM" (fixed) CI

This mode is valid for "CH2 CL2 RELAY" output only. Pulse-width modulation (PWM) of a signal or power source involves the modulation of its duty cycle, to either convey information over a communications channel or control the amount of power sent to a load. Using fixed mode is possible to set operating time to switch on or off selected output.

During this time if reading value will move towards a set value (on or off) the PWM will operate the output on timered basis. Reaching the set value the PWM will permanently leave on (for selected amount of time) or off the output.

Parameters to set for this mode are:

CI range: two CI values within PWM operates.

Ton: ON period, during output activity.

Toff: OFF period, during output activity.

For example: set first CI alue (OFF) at 1.40. Set second CI value (ON) at 0.80.

Set "working-pause" output activity with Toff 0 seconds and Ton 80 seconds.

For reading values \geq to 1.40 the output will be permanently OFF.

For reading values \leq 0.80 the output will be ON with activity based on Ton and Toff.

For reading values within working range operating mode is on HYSTERESIS base. Once reading value is 1.40 mg/l will be permanently off until it will reaches 0.80 mg/l.

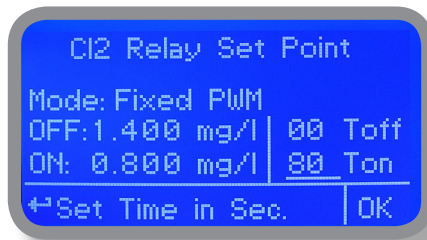

9. "Probe Calibration", pH

Full pH calibration procedure involves two calibration points and it requires two buffer solutions. Default buffer solutions are pH 4.00 and pH 7.00. pH reading value can be also compensated from "pH compensation" menu. From "Menu Calibration" choose "pH probe".



Fast Calibration procedure involves one point calibration (choose value closest to real field application)

In the following example instrument will calibrate pH using default buffer solutions values.

Note: this procedure assumes that instrument is correctly configured and a working pH probe connected. Otherwise unattended results may occur.

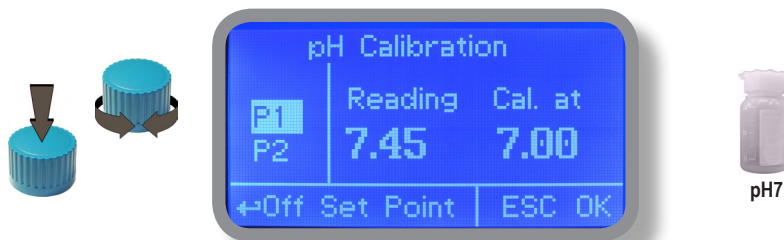

Calib 1st Point.

Once into "pH Calibration" menu move wheel on "P1" then press wheel to enter into first point calibration submenu. Prepare 7.00pH buffer solution and dip probe's sensor on it. Wait until reading value is stable and according to buffer solution value move wheel until it is the same on display ("Cal. at" field) Default value is 7.00pH. To end procedure move cursor on "OK" and press wheel to proceed to next step.

Note: buffer solution value may change if environment temperature it's different than 20°C. Read solution's label for more information. According to this occurrence "pH Default" must be changed.

9. "Probe Calibration", pH

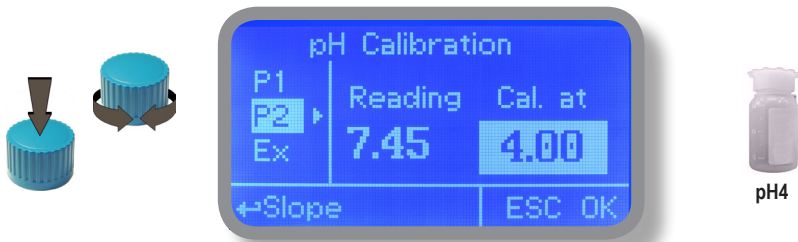

Calib 2nd Point.

Move wheel on "P2" then press wheel to enter into second point calibration submenu. Prepare 4.00pH buffer solution and dip probe's sensor on it. Wait until reading value is stable and according to buffer solution value move wheel until it is the same on display ("Cal. at" field) Default value is 4.00pH.

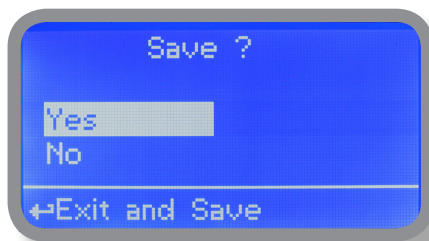

To end procedure move cursor on "OK" and press wheel to proceed to "Save" request screen. Move wheel on "YES" to save or "NO" to discard changes.

Note: buffer solution value may change if environment temperature it's different than 20°C. Read solution's label for more information. According to this occurrence "pH Default" must be changed.

9.1 "Probe Calibration", Cl

Full Cl calibration procedure involves probe's selection, Zero (P1) and 2nd Point (P2) calibration. From "Menu Calibration" choose "Cl probe". Prior to calibrate chlorine probe please choose if enable or disable pH compensation within related menu. **The zero calibration is available with 2 mg/l scale only.**

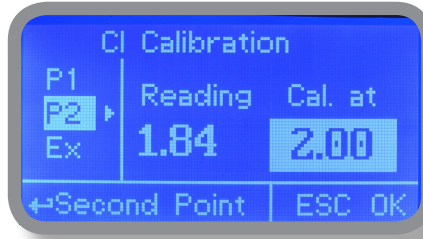
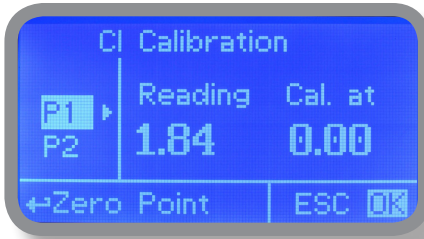

Fast Calibration procedure involves one point calibration (choose value closest to real field application)

Note: This procedure assumes that instrument is correctly configured and a working Chlorine probe connected and installed on system. Measurement must be performed using plant water. Otherwise unattended results may occur.

Calib Zero (P1).

Once into "Cl calibration" menu move on "P1" then press wheel to enter into calibration mode. For a correct system calibration proceed as follows. For open amperometric-cell holders just stop water flow .

- install an "activated carbon filter" prior to probe's holder.
- let system water flow into probe holder for about 30 minute .
- press wheel (cursor must be on "Cal.at"). Remove filte .



Carbon Filter System

Calib 2nd point (P2).

Now move on "P2" then press wheel to enter into calibration mode. For a correct system calibration use a Photometer or a DPD device to read chlorine on system. Enter value using the wheel then move cursor on "OK". Now press the wheel.

To end procedure move cursor on "OK" and press wheel to proceed to "Save" request screen. Move wheel on "YES" to save or "NO" to discard changes. If an error occurred during calibration procedure then the instrument will show an error message and will ask to proceed to a new calibration, cancel current operation or restore default settings.



Photometer

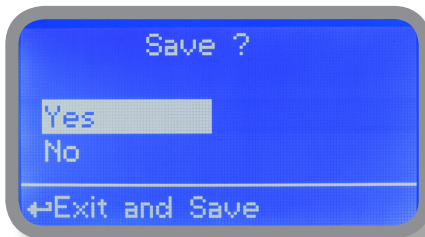

9.2 "Probe Calibration", °C - Temperature

A professional thermometer is required to obtain a reliable calibration. From "Menu Calibration" choose "Temp probe".

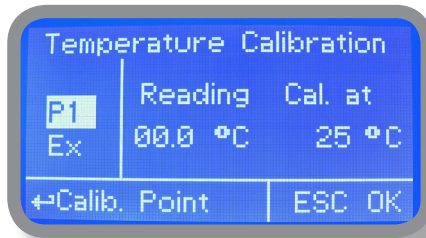

Note: This procedure assumes that instrument is correctly installed and configured, connected to a working PT100.. Calibrate using plant's temperature otherwise unattended results may occur.

Using an external thermometer read actual temperature and edit related field "Cal. at". Confirm by pressing wheel.

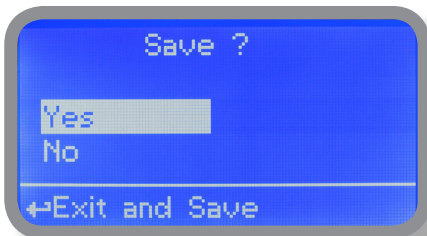

To end procedure move cursor on "OK" and press wheel to proceed to "Save" request screen. Move wheel on "YES" to save or "NO" to discard changes. If an error occurred during calibration procedure then the instrument will show an error message and will ask to proceed to a new calibration, cancel current operation or restore default settings.

10. "Parameters"

From "Menu Calibration" choose "Parameters". This menu allows to set a delay (max 60 minutes) before pumps begin to feed. Furthermore use this menu to set pH pump startup priority and to change default passcode.



Feeding Delay.

Move on "Feeding Delay" then press wheel. Choose a value between 0 (disabled) and 60 minutes (maximum delay time). This feature can be used to accord a startup delay for the pumps. Delay occurs when instrument is powered.

Mode.

Move on "Mode" then press wheel. If both pumps need to operate, a startup priority can be set to allow the pH pump to begin to feed prior to Cl pump. Choose "pH priority" to enable this function. Cl pump will begin to dose when pH pump has stopped.

Tau.

If probes reading values are changing too fast increase TAU value to stabilize them. Default value is 05. Maximum value is 30.

New Pcode.

See page 10.

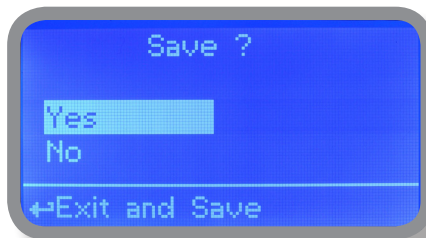

To end procedure move cursor on "OK" and press wheel to proceed to "Save" request screen. Move wheel on "YES" to save or "NO" to discard changes.

11. "Output Manager"

From "Menu Calibration" choose "Output Manager". This menu allows to manually operate all outputs for a settable time. Set to "AUTO" for normal operating mode. Set to "OFF" to permanently disable outputs.

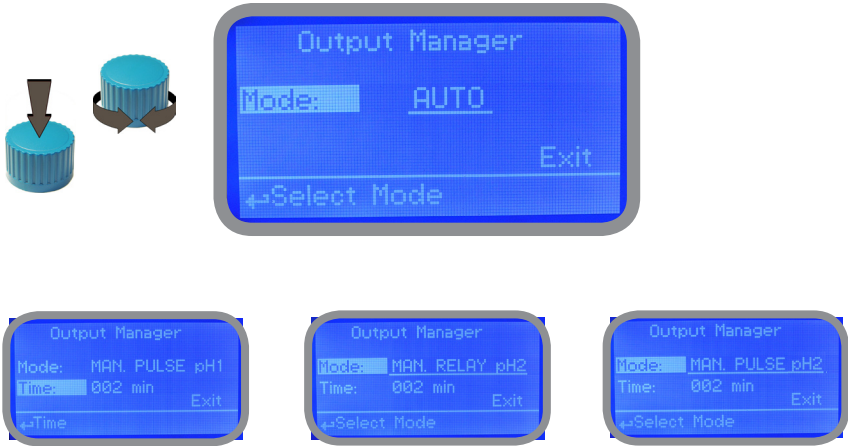

Press wheel to move cursor on "TIME" field. Once here, choose a working time between 0 (disabled) or 199 minutes. Move on "EXIT", then press wheel.

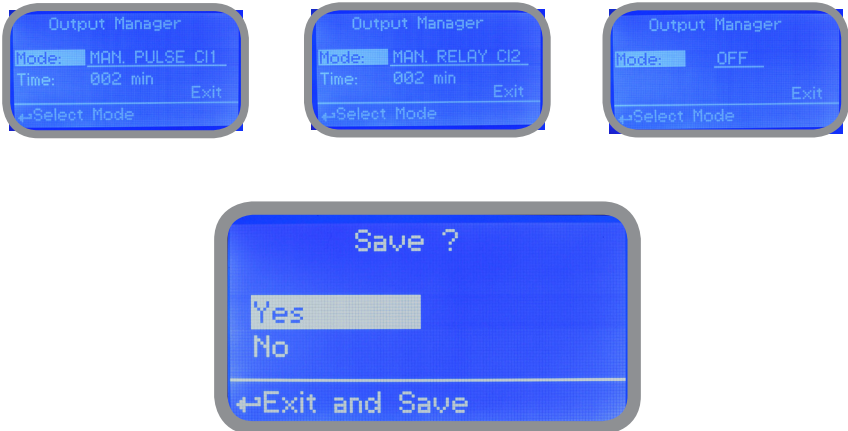

Choose "YES" to save changes. Exit from main menu. Main display will show a countdown for selected output. To stop this countdown go back to "Output Manager" menu and choose "AUTO" as working mode or wait until countdown ends. **This function can be used for priming purposes.**

12. "Instrument Reset"

"Instrument Reset" menu allows user to reset several parameters (channel, temperature, instrument and setpoint) Press wheel then change value to restore (multiple choices are allowed) to "ON", press wheel again, move on "OK" then finally press wheel. The instrument will go back to main menu and values will be restored.

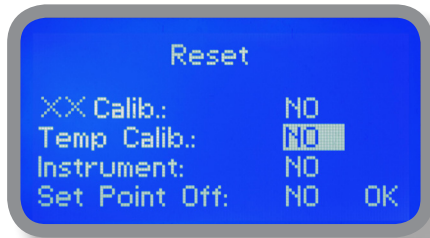
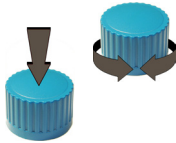

13. "Dosing Alarm"

Use this menu to assign a maximum time to the pumps for reaching the setpoint. If set time ends and the pumps are still dosing, within this menu is possible to STOP them or just to show an alarm message. Function can be disabled selecting "OFF" instead of a number (minutes). Dosing alarm can be set for both or just one pump.

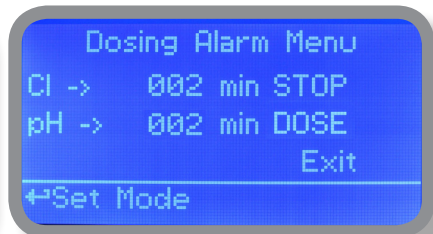
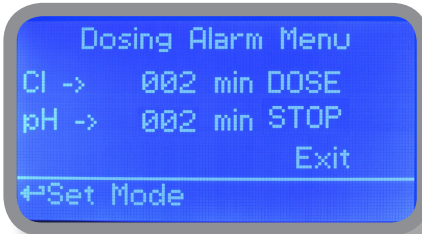

E.g. To set CI pump to stop after time ends and setpoint isn't still reached press wheel, choose maximum time, press wheel move on next field and choose "STOP". Time can be set between 0 and 100 minutes. When satisfied with settings move on exit and press wheel.

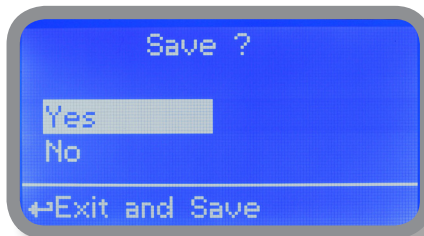

To end procedure move cursor on "OK" and press wheel to proceed to "Save" request screen. Move wheel on "YES" to save or "NO" to discard changes.

14. "International"

Use this menu to set international parameters as UNIT FORMAT (Europe IS or USA), Local Time and Date.

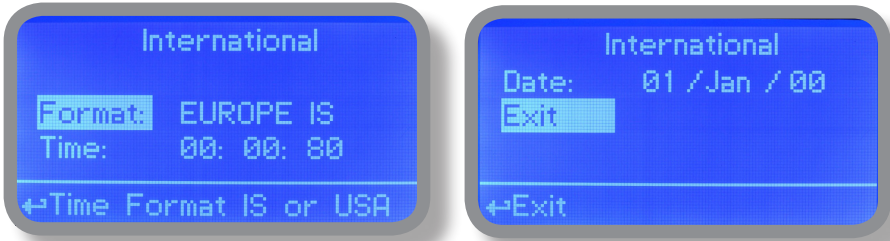

Format.

Use this option to use European or USA units format. See table for differences.

EUROPE IS (International Standard)	USA
Date (DD/MMM/YY)	Date (MMM/DD/YY)
Time 24h	Time AM / PM
°C	°F

Time.

Use this option to set local time.

Date.

Use this option to set date.

Move on exit to end changes.

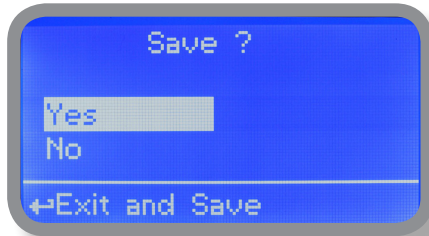

To end procedure move cursor on "OK" and press wheel to proceed to "Save" request screen. Move wheel on "YES" to save or "NO" to discard changes.

15. "Probe Failure"

Use this menu to assign a maximum time for connected probes to stay in "stuck" condition. A stuck probe (it remains on same reading value for some time) means that probably probe itself is damaged. Within this menu is possible to STOP pumps or just to show an alarm message (probe failure) . Function can be disabled selecting "OFF" instead of a number (minutes). This function can be set for both or just one probe.

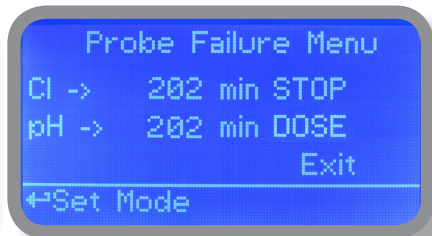
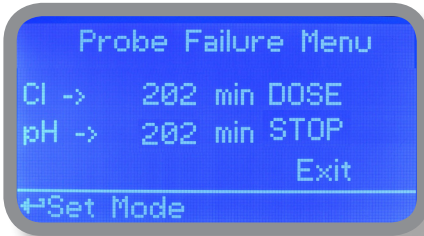

E.g. To set CI pump to stop after time ends and probe doesn't change reading values press wheel, choose maximum time, press wheel move on next field and choose "STOP". Time can be set between 100 and 254 minutes. When satisfied with settings move on exit and press wheel

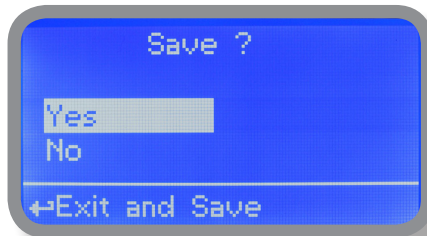

To end procedure move cursor on "OK" and press wheel to proceed to "Save" request screen. Move wheel on "YES" to save or "NO" to discard changes.

16. "Flow Contact"

Flow contact (see "SEPR" blocks on page 4) can be enabled to stop a dosing procedure using a N.O. contact mode (normally open) or N.C. contact mode (normally closed) when status on blocks changes. Rotate wheel to choose between: "DISABLE", "REVERSE" (N.O. contact) or "DIRECT" (N.C. contact).

Furthermore "Flow contact" can starts after a specified time when contact status change . To set it move wheel on "Time:00 min", click it and rotate to choose time (from 0 to 99 minutes). Confirm selection by clicking wheel

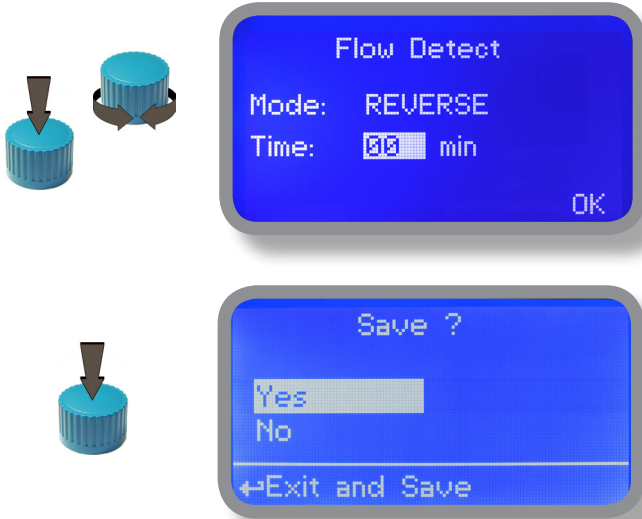

To end procedure move cursor on "OK" and press wheel to proceed to "Save" request screen. Move wheel on "YES" to save or "NO" to discard changes.

17. "Service"

This "view only" menu shows probes reading live and instrument ID for USB LOG connection (if device's connected). Press "ESC" to exit.

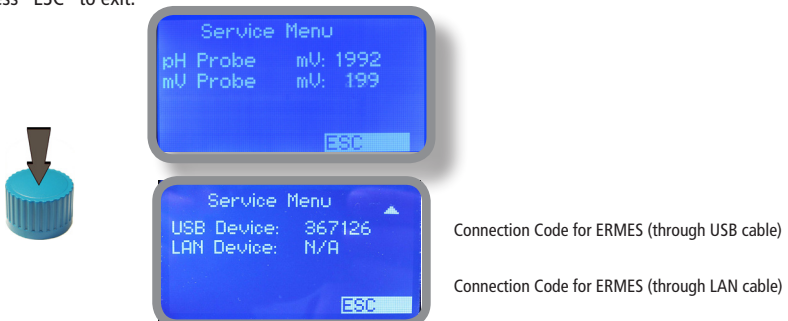

18. "SMS"

Log setup stores instrument activities when an alarm (flo , level, out of range reading, etc.) occurs.



Log activity recording can be started by moving wheel on "Mode: Disable" and changing it to "Mode: Enable". Log activity starting time can be set to begin at specified time by entering "Time". Activities data are collected every specified hour or minute . Edit this parameter by moving wheel on "Every: 00:00" and changing it to desired time.

ID and Station Name as appears on a received SMS from instrument



19. "mA Outputs"

This menu allows to configure mA current outputs for pH Chlorine and Temperature channels. Options to set are:

MODE (selectable between 0-20 or 4-20 mA current output)

Max mA: maximum probe's reading value at 20 mA current

Min mA: minimum probe's reading value at 0 or 4 mA current

Disable / Enable on alarm: enable or disable output on alarm condition (flo , level, probe failure, dosage, out of range)

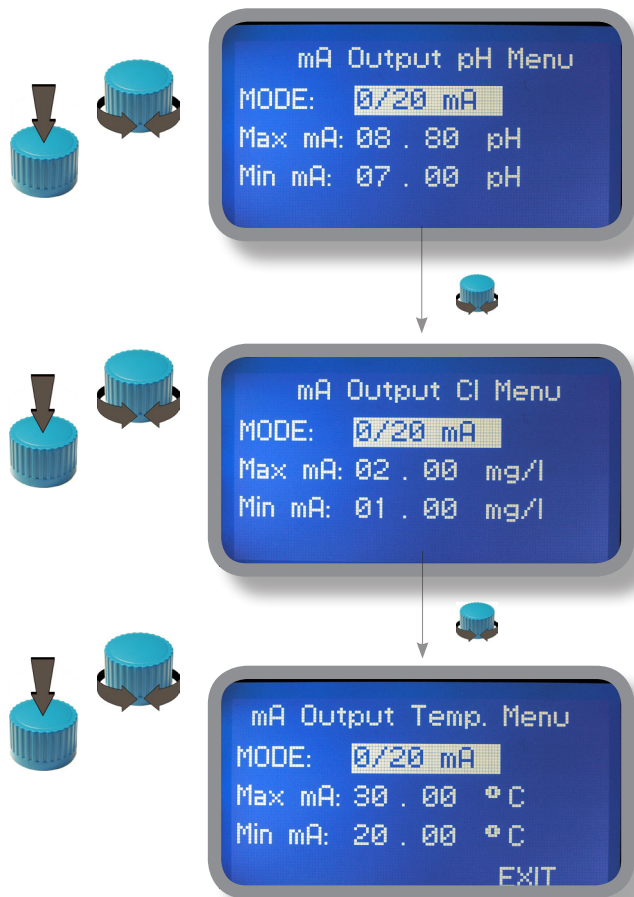

Rotate wheel to move within all 3 channels. Click wheel to select parameter and rotate wheel to change it. Click wheel again and rotate wheel to move cursor on next parameter. To end procedure move cursor on "EXIT" and press wheel to proceed to "Save" request screen. Move wheel on "YES" to save or "NO" to discard changes.

This menu is available only for "LDPHxx" instrument series with current outputs option enabled.

20. "Out of range alarm"

"Out of range alarm" menu defines the minimum and maximum pH and Chlorine probe read value before to stop dosing activity and to show an alarm message.



Move wheel on "Min/Max pH Range" to set "out of range" condition for pH probe then click on wheel to enter into "Min/Max Range menu".



Move wheel on "Min/Max Cl Range" to set "out of range" condition for Chlorine probe then click on wheel to enter into "Min/Max Range menu".

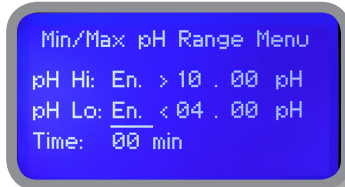

Move wheel on "pH Hi: Dis." and change status from "Dis." (option disabled) to "En." (option enabled) by clicking on wheel and rotating it. Press wheel again and move on next field. Press wheel and enter a value for HIGH alarm.



Move wheel on "Cl Hi: Dis." and change status from "Dis." (option disabled) to "En." (option enabled) by clicking on wheel and rotating it. Press wheel again and move on next field. Press wheel and enter a value for HIGH alarm.

Repeat procedure for "pH Lo: Dis." and enter a value for LOW alarm.

Repeat procedure for "Cl Lo: Dis." and enter a value for LOW alarm.

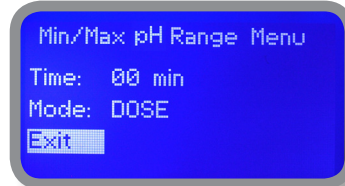

As last option enter "Time" (max 99 minutes) after which if lower or higher read value condition stays then the alarm occurs (to set into mode field)



As last option enter "Time" (max 99 minutes) after which if lower or higher read value condition stays then the alarm occurs (to set into mode field)

To change alarm mode move wheel on "Mode", press it and choose between "DOSE" (connected pumps will not stop dosing activity when read value is out of range) or "STOP" (connected pumps will stop dosing activity when read value is out of range and an alarm message is displayed).

To change alarm mode move wheel on "Mode", press it and choose between "DOSE" (connected pumps will not stop dosing activity when read value is out of range) or "STOP" (connected pumps will stop dosing activity when read value is out of range and an alarm message is displayed).

21. Technical information.

Power supply: 85÷264 VAC
pH range: 0 ÷14 ; Cl range: 0÷10 mg/l

Environment Temperature: -10 ÷ 45°C (14 ÷ 113°F)

Chemical Temperature: 0 ÷ 50°C (32 ÷ 122°F)

Installation Class: II

Pollution Level: 2

Packaging and Transporting Temperature: -10 ÷ 50°C (14 ÷ 122°F)

Protection degree: IP 65

Product	Formula	Ceram.	PVDF	PP	PVC	SS 316	PMMA	Hastel.	PTFE	FPM	EPDM	NBR	PE
Acetic Acid, Max 75%	CH3COOH	2	1	1	1	1	3	1	1	3	1	3	1
Hydrochloric Acid, Concentrate	HCl	1	1	1	1	3	1	1	1	1	3	3	1
Hydrofluoric Acid 40%	H2F2	3	1	3	2	3	3	2	1	1	3	3	1
Phosphoric Acid, 50%	H3PO4	1	1	1	1	2	1	1	1	1	1	3	1
Nitric Acid, 65%	HNO3	1	1	2	3	2	3	1	1	1	3	3	2
Sulphuric Acid, 85%	H2SO4	1	1	1	1	2	3	1	1	1	3	3	1
Sulphuric Acid, 98.5%	H2SO4	1	1	3	3	3	3	1	1	1	3	3	3
Amines	R-NH2	1	2	1	3	1	-	1	1	3	2	3	1
Sodium Bisulphite	NaHSO3	1	1	1	1	2	1	1	1	1	1	1	1
Sodium Carbonate (Soda)	Na2CO3	2	1	1	1	1	1	1	1	2	1	1	1
Ferric Chloride	FeCl3	1	1	1	1	3	1	1	1	1	1	1	1
Calcium Hydroxide (Slaked Lime)	Ca(OH)2	1	1	1	1	1	1	1	1	1	1	1	1
Sodium Hydroxide (Caustic Soda)	NaOH	2	1	1	1	1	1	1	1	2	1	2	1
Calcium Hypochlor.(Chlor.ted Lime)	Ca(OCl)2	1	1	1	1	3	1	1	1	1	1	3	1
Sodium Hypochlorite, 12.5%	NaOCl + NaCl	1	1	2	1	3	1	1	1	1	1	2	2
Potassium Permanganate, 10%	KMnO4	1	1	1	1	1	1	1	1	1	1	3	1
Hydrogen Peroxide, 30% (Perydrol)	H2O2	1	1	1	1	1	3	1	1	1	2	3	1
Aluminium Sulphate	Al2(SO4)3	1	1	1	1	1	1	1	1	1	1	1	1
Copper-II-Sulphate (Roman Vitriol)	CuSO4	1	1	1	1	1	1	1	1	1	1	1	1

Resistance rating: (1: Resistant) ; (2: Fairly resistant) ; (3: Not resistant)

Polyvinylidene fluoride (PVDF) Pump Heads, valves, fitting tubing

Polypropylene (PP) Pump Heads, valves, fitting level floate

PVC Pump Heads

Stainless steel (SS 316) Pump Heads, valves

Polymethyl Metacrilate (Acrylic) PMMA Pump Heads

Hastelloy C-276 Injection valve spring

Polytetrafluoroethylene (PTFE) Diaphragm

Fluorocarbon (Viton® B) Sealings

Ethylene propylene (EPDM) Sealings

Nitrile (NBR) Sealings

Polyethylene (PE) Tubing

22. SEPR configuratio

SEPR "Flow Sensor" configuration for two instruments

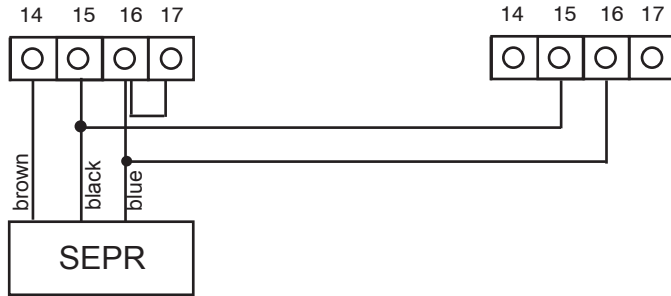

Configuration of a Flow Switch with a voltage free contact and two instruments

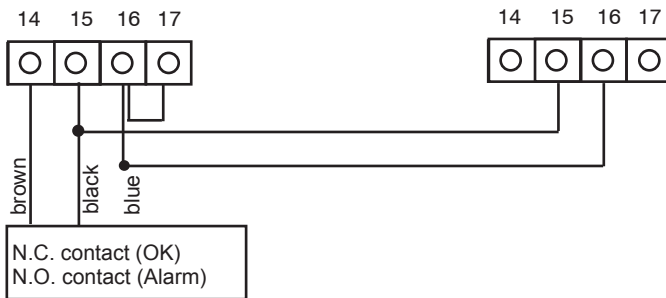

NPED4

Appendix - MDCL1 probe series module

Located under mainboard cover there are two connectors that can be used to install probe modules. Modules come pre-installed upon request and may appear different as shown (different configurations) Identify installed modules to correctly connect probes. From Calibration Menu choose "Select Probe" and according to installed probe select required model.

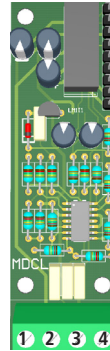

Module suitable for:

- ECL1
- ECL2
- ECL3
- ECL8
- ECL9
- ECL10
- ECL11
- ECL17
- ECL18
- EBR1/20

Connect probe as follows:

- Block n.1 : Brown(+) wire
- Block n.2 : White(-) wire
- Block n.3 : Green(IN) wire
- Block n.4 : Yellow(GND) wire

MDCL1 probe series probe module require to enable or disable pH compensation based on temperature and / or Cl compensation based on pH. Within "Main menu", select "Compensation" then press wheel then choose "ON". To disable compensation choose "OFF". Compensation are both independent. Changes into this menu requires to recalibrate probe.

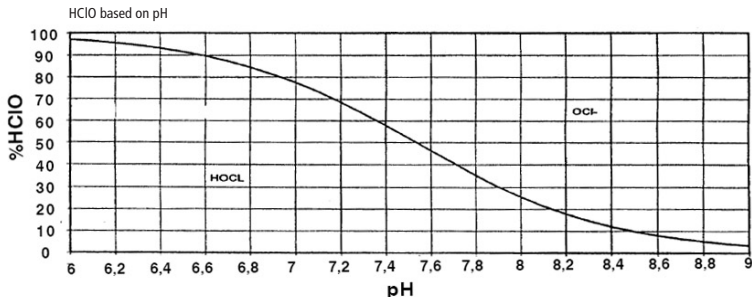
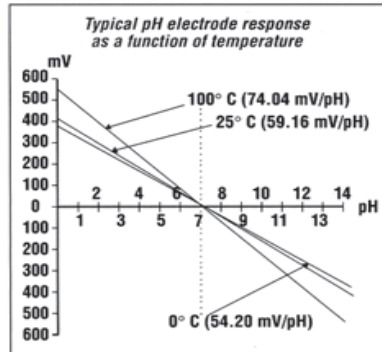
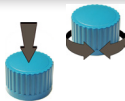
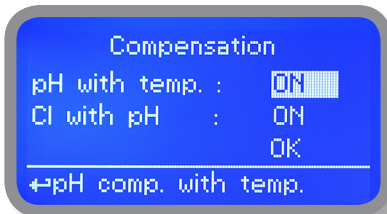

Appendix - MDCL6 probe series module

Located under mainboard cover there are two connectors that can be used to install probe modules. Modules come pre-installed upon request and may appear different as shown (different configurations) Identify installed modules to correctly connect probes. From Calibration Menu choose "Select Probe" and according to installed probe select required model.

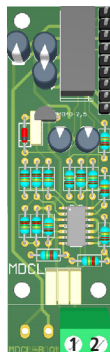
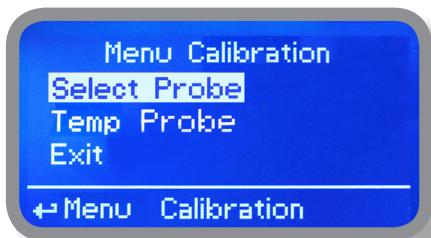

Module suitable for:

ECL4
ECL5
ECL6
ECL7
ECL12

Connect probe as follows:

Block n.1 : Black(-) wire
Block n.2 : Red (+) wire

MDCL6 probe series probe module require to enable or disable pH compensation based on temperature and / or Cl compensation based on pH. Within "Main menu", select "Compensation" then press wheel then choose "ON". To disable compensation choose "OFF". Compensation are both independent. Changes into this menu requires to recalibrate probe. See previous page for screenshot and dissociation graph.

Appendix - MDSCL module for SCLxx probes series

Located under mainboard cover there are two connectors that can be used to install probe modules. Modules come pre-installed upon request and may appear different as shown (different configurations) Identify installed modules to correctly connect probes.

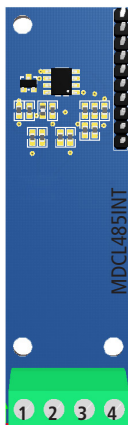

Connect chlorine probe (mod. SCLxx) to this module as follows:

- 1 (-485) green wire
- 2 (+485) white wire
- 3 (GND) black wire
- 4 (+5VDC) red wire

To properly install the probe, connect it before to turn on the instrument

Appendix Communication HARDWARE - "SMS/GSM" Module

Located under mainboard cover there is a four pins connector that can be used to install USB, ETHERNET or MODEM modules. Modules come pre-installed upon request and may appear different as shown (different configurations) **"SMS/GMS module"** can be configured to send SMS messages containing critical instrument information.

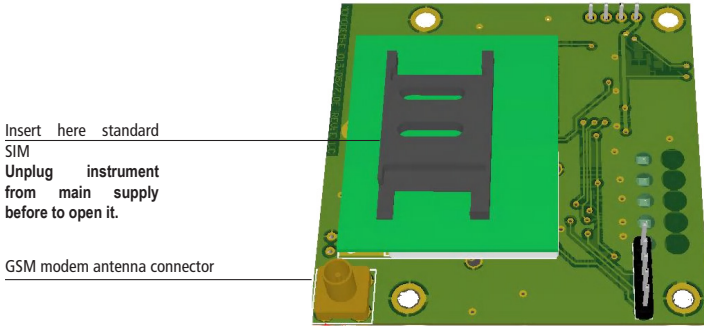

Insert here standard
SIM
Unplug instrument
from main supply
before to open it.

GSM modem antenna connector

To obtain reliable results with this feature please check the following list:

- Make certain the antenna location is not shielded by metal objects or near sources of electrical 'noise'.
- Do not route the cable where it could be pinched in doors, windows etc.
- Secure the antenna cable
- Ensure that SIM into "SMS/GSM module" is properly inserted, activated and within operator range.
- Set instrument ID / NAME from "RS485 Setup" menu and configure "Out of Range Alarm" menu.

Within "Main menu" select "SMS MENU" to enable SMS service and enter SMS receiver phone numbers.



Up to three numbers for sending SMS can be stored into LDPHCL memory. SMS recipient will receive an SMS containing instrument ID, NAME and status. Number formats can be stored using international prefix "+", international prefix "00" or local.

WARNING: THIS FUNCTION COULD NOT BE FREE OF CHARGE. DEPENDING ON YOUR OPERATOR CONTRACT IT COULD GENERATE PAYING SMS TRAFFIC !

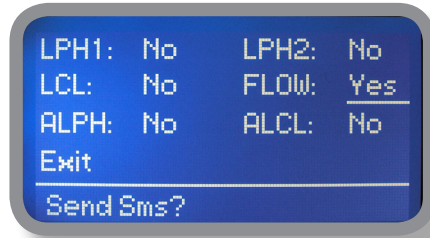

To enable warning message for related alarm condition choose "YES", to disable choose "NO". Then move wheel on Exit and SAVE configuration **SMS will be sent when one or more ("YES") fields will change.**

LPH1 or 2 : level alarm for PH1 or PH2 levels
LCL: level alarm for Chlorine
FLOW: flow alar
ALPH: out of reading range for pH probe
ALCL: out of reading range for Chlorine probe

WARNING: TO AVOID UNDESIRED MESSAGES USE CAREFULLY THIS SETUP!

Appendix Communication HARDWARE - "LOG USB" Module

Located under mainboard cover there is a four pins connector that can be used to install "USB data log module" or "SMS module". Modules come pre-installed upon request and may appear different as shown (different configurations)

"USB data log module" records instrument activities. These information can be permanently stored into a standard USB pendrive. Pendrive can be connected to a PC using "ERMES" web www.ermes-server.com to review and print instrument's activities. To obtain reliable results with this feature please set instrument ID and NAME from "RS485 Setup" menu and activate log recording from "LOG SETUP" menu.

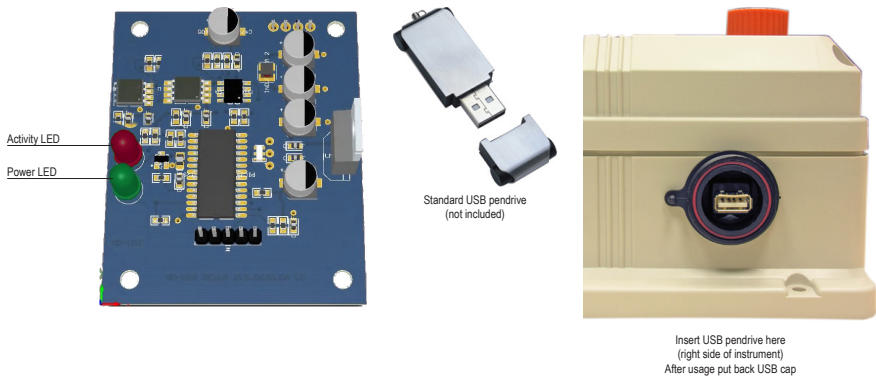

HOW TO RECORD INSTRUMENT'S ACTIVITIES INTO USB PENDRIVE ?

Insert USB pendrive into USB connector (located on the right side of instrument). Instrument will save data log on USB pendrive. After succeeded in saving data it will ask if delete instrument's log or not (anyway USB pendrive will not be formatted). Move wheel on "YES" to delete log info from instrument and return to main screen or "NO" to leave log info on instrument and return to main screen. **Wait about 30 seconds to safety remove the USB pendrive.**



HOW TO REVIEW INSTRUMENT'S ACTIVITIES RECORDED INTO USB PENDRIVE ?

It's necessary to connect to web "ERMES" www.ermes-server.com to review USB pendrive info on a PC.

Appendix Communication - Software

“RS485” menu.

Prior to install the instrument into an RS485 local system a unique ID NUMBER (from 1 to 30) and ID NAME (station name) must be set. Rotate wheel and edit fields. If ID number has already assigned an error message will follow after ID Check (move cursor on CHECK and press wheel). In this event try using another number.



“GSM SMS” menu.

Instrument may remotely send SMS alarm messages using its own modem (sold as option). It can be configured as follows:

SMS1 / SMS2 /SMS3.

Using the wheel enter a mobile phone that will receive alert SMS messages if something wrong occurs. SMS number must be set using local number format. For example : 3391349134 will send an SMS message to mobile phone. Log level (and SMS frequency alert) may be set using options in “ACTIVE MSG” within “GSM menu”.



- TO AVOID UNDESIRED MESSAGES USE CAREFULLY LOG SETUP -

- WARNING: THIS FUNCTION COULD NOT BE FREE OF CHARGE. DEPENDING ON YOUR OPERATOR CONTRACT IT
COULD GENERATE PAYING SMS TRAFFIC !

Appendix Communication - Software

“TCP/IP” menu.

The instrument may be remotely operated using a standard ethernet connection (sold as option). A static or dynamic IP address and a CAT5 ethernet cable is required. According to your network capacity connection speed is 10/100Mbps. To obtain a valid IP address and subnet mask contact your net administrator. Enter parameters and move cursor on “SAVE” to store parameters then move on “OK” and press wheel to save and activate configuration.

Based on your network configuration choose to obtain network parameters automatically (DYNAMIC) or manually (STATIC).



See “ERMES Communication Software” manual for proper PC software configuration.

What is a static IP address/dynamic IP address?

A static IP address is a number (in the form of a dotted quad) that is assigned to a computer by an Internet service provider (ISP) to be its permanent address on the Internet. Computers use IP addresses to locate and talk to each other on the Internet, much the same way people use phone numbers to locate and talk to one another on the telephone. When you want to visit whatis.com, your computer asks a domain name system (DNS) server (think telephone information operator) for the correct dotted quad number (think phone number) for whatis.com and your computer uses the answer it receives to connect to the whatis.com server. It would be simple if every computer that connects to the Internet could have its own static IP number, but when the Internet was first conceived, the architects didn't foresee the need for an unlimited number of IP addresses. Consequently, there are not enough IP numbers to go around. To get around that problem, many Internet service providers limit the number of static IP addresses they allocate, and economize on the remaining number of IP addresses they possess by temporarily assigning an IP address to a requesting Dynamic Host Configuration Protocol (DHCP) computer from a pool of IP addresses. The temporary IP address is called a dynamic IP address.

Requesting DHCP computers receive a dynamic IP address (think temporary phone number) for the duration of that Internet session or for some other specified amount of time. Once the user disconnects from the Internet, their dynamic IP address goes back into the IP address pool so it can be assigned to another user. Even if the user reconnects immediately, odds are they will not be assigned the same IP address from the pool. To keep our telephone analogy going, using a dynamic IP address is similar to using a pay phone. Unless there is a reason to receive a call, the user does not care what number he or she is calling from.

There are times, however, when users who connect to the Internet using dynamic IP wish to allow other computers to locate them. Perhaps they want to use CU-SeeMe or use a VoIP application to make long distance phone calls using their IP connection. In that case, they would need a static IP address. The user has two choices; they can contact their ISP and request a static IP address, or they can use a dynamic DNS service. Either choice will probably involve an additional monthly fee.

Using a dynamic DNS service works as if there was an old-fashioned telephone message service at your computer's disposal. When a user registers with a DNS service and connects to the Internet with a dynamic IP address, the user's computer contacts the DNS service and lets them know what IP address it has been assigned from the pool; the service works with the DNS server to forward the correct address to the requesting DHCP computer. (Think of calling the message service and saying "Hi. I can be reached at 435.44.32.111 right now. Please tell anyone who tries to reach me to call that number.") Using a dynamic DNS service to arrange for computers to find you even though you are using a dynamic IP address is the next-best thing to having a static IP.

Appendix Communication - Software

“GPRS” menu.

Instrument may be remotely operated using an embedded standard GPRS modem (sold as option). In order to activate this service please ensure that the following steps are correctly completed:

- Make certain the antenna location is not shielded by metal objects or near sources of electrical 'noise'.
- Make certain the distance from the antenna to the “Instrument” unit is within cable length.
- Do not route the cable where it could be pinched in doors, windows etc.
- Ensure that SIM into “Instrument” modem is correctly inserted, activated and within operator range.

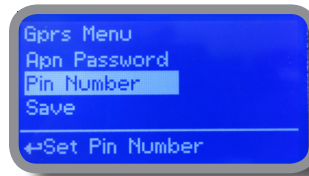
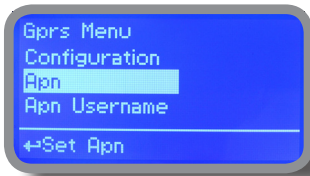

Instrument can be set for ERMES services enabled (Configuration option set to “ERMES YES”) or messages only (Configuration option set to “ERMES NO”) based on your SIM data access parameters. For manual configuration option enter APN (access point name) and SIM phone number. Move wheel on “OK” to save and move on “ESC” to go back to main menu.

Don't forget to enter SIM CODE into PIN NUMBER menu to unlock SIM.

WARNING: THIS FUNCTION COULD NOT BE FREE OF CHARGE. DEPENDING ON YOUR OPERATOR CONTRACT IT COULD GENERATE PAYING DATA TRAFFIC !

“Email” menu.

If Ethernet module or GPRS module is installed (sold as option) the instrument can be configured to send email alarm messages up to two recipients. Click on “Email 1” or “Email 2” and enter email address.

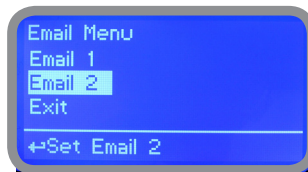

Access point name (APN) identifies an IP packet data network (PDN), that a mobile data user wants to communicate with. In addition to identifying a PDN, an APN may also be used to define the type of service, (eg connection to wireless application protocol (WAP) server, multimedia messaging service (MMS)), that is provided by the PDN. APN is used in 3GPP data access networks, eg general packet radio service (GPRS), evolved packet core (EPC).

Appendix Communication - LOG

This function, when enabled, allows to record and send to ERMES server all instrument activities (date, time, temperature, levels, alarms, totalizers, outputs status) for a set period (EVERY) and starting from a certain time (TIME) .

Note: SET TIME AND DATE PRIOR TO ENABLE THE LOG. If not fed after 30 days the instrument will lose current date and time.



TIME: log starting time (format 23h 59min)

EVERY: frequency of recording (format 23h 59min)

E.g.: To set the instrument to begin logging events starting from 16:00 every hour set TIME to 16h: 00 and EVERY of 1h: 00m

Note: To view on instrument's display the archived logs select LOGVIEW



Appendix - MODBUS

Modbus is a serial communications protocol originally published by Modicon (now Schneider Electric) in 1979 for use with its programmable logic controllers (PLCs). Simple and robust, it has since become a de facto standard communication protocol, and it is now a commonly available means of connecting industrial electronic devices.

From main menu select COMMUNICATION then MODBUS to access the options. Set the communication speed according to the PLC system available. Set the ID assigning an UNIQUE address to avoid conflict .

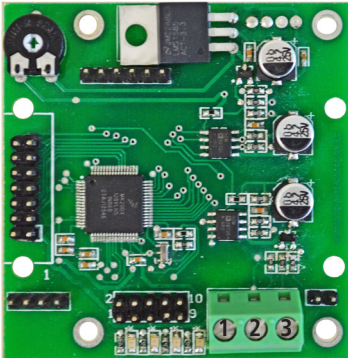
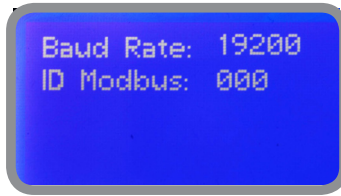

To access the module MODBUS open the instrument only after power is switched off!

Never make connections with the instrument powered!



WARNING

- 1: GND
- 2: A-RS485 (+)
- 3: B-RS485 (-)

Appendix - Dimensions

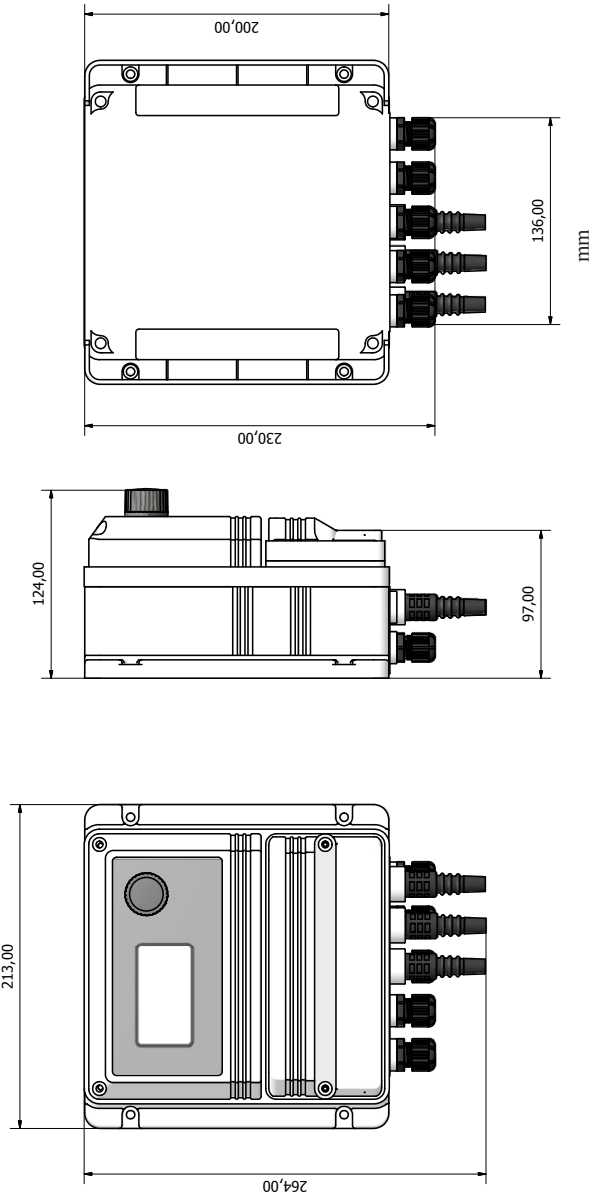

Appendix - SETUP and SLOT SENSORS ASSIGNMENT

To assign a probe to a slot between the two available connecting the probe module to the required slot and repeating the procedure for each module. Within calibration menu select "PROBES SLOT ASSIGN." and assign the probe to the required SLOT setting it into "NEW SLOT" field Repeat procedure for the other probe always installing one at a time. At the end of procedure you can enter both modules with probes in the assigned slot.

To complete procedure please power cycle the controller. **Note: chlorine probe will be detected if assigned to slot 0.**

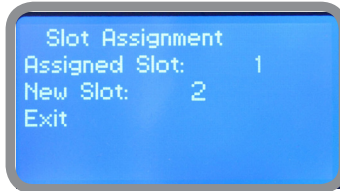
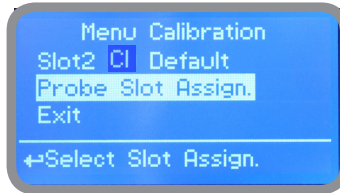

Appendix - WiFi Connection

Within Communication Menu choose "WiFi" to bring wireless sub-menu. Wait until desired wireless network appears, move wheel on it then click. Otherwise click on "SCAN" to restart the search. Enter WEP / WPA / WPA2 password (if required) and wait until connection has been established and WiFi signal strength appears. To obtain a reliable connection be sure to install the controller within WiFi range. See your router features and installation procedure for best results.

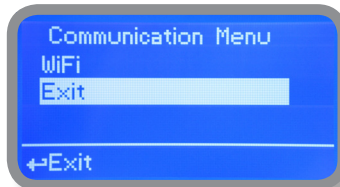

WiFi signal strength

Index

1. Introduction	3
2. The wheel.....	3
3. Mainboard Connections.....	4
4. Main Screen	5
5. Quick status check.....	6
6. Password	7
7. "Main Menu" list	8
8. "Set-Point", pH working modes	9
8.1 "Set-Point", pH (on/off).....	9
8.2 "Set-Point", pH (on/off).....	10
8.3 "Set-Point", pH (proportional)	11
8.4 "PWM" (proportional), pH.....	12
8.5 "PWM" (fixed) pH	13
8.6 "Set-Point", Cl working modes	14
8.8 "Set-Point", Cl (proportional)	15
8.9 "PWM" (proportional), Cl.....	16
8.10 "PWM" (fixed) Cl	17
9. "Probe Calibration", pH.....	18
9.1 "Probe Calibration", Cl.....	20
9.2 "Probe Calibration", °C - Temperature	21
10. "Parameters"	22
11. "Output Manager"	23
12. "Instrument Reset"	24
13. "Dosing Alarm"	25
14. "International"	26
15. "Probe Failure"	27
16. "Flow Contact"	28
17. "Service"	28
18. "SMS"	29
19. "mA Outputs"	30
20. "Out of range alarm"	31
21. Technical information.....	32
22. SEPR configuration	33
Appendix - MDCL1 probe series module	34
Appendix - MDCL6 / MDSCL probes series modules	35
Appendix Communication HARDWARE - "SMS/GSM" Module	36
Appendix Communication HARDWARE - "LOG USB" Module.....	37
Appendix Communication - Software.....	38
Appendix MODBUS	42
Appendix Dimensions.....	43
Appendix Probe Slot Assign.	44
Appendix WIFI.....	45

Information on this manual may contain technical inaccuracies or typographical errors.
The information contained may be changed at any time without prior notification or obligation.



When dismantling this instrument please separate material types and send them according to local recycling disposal requirements.
We appreciate your efforts in supporting your local Recycle Environmental Program.
Working together we'll form an active union to assure the world's invaluable resources are conserved.