

# VMS MF - VMSA MF

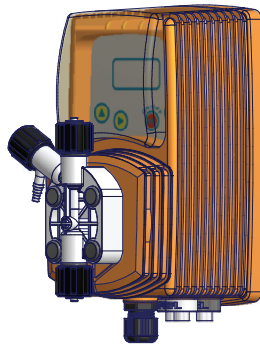

PRODUCT LABEL



VMS MF

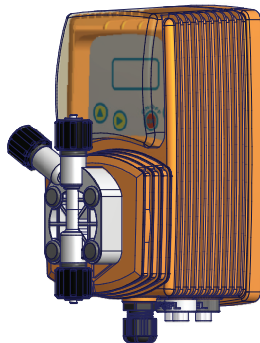

VMSA MF

SOLENOID DRIVEN METERING PUMPS  
WITH DIAPHRAGM

EN

OPERATING MANUAL



This operating instructions contains safety information that if ignored can endanger life or result in serious injury.

Read these instructions **carefully** before use and keep them for future reference.

Information and specifications on this manual could be uncorrect or could have printing errors. Specifications are subject to change without notice.

Version: R1-02-18



## NORME CE EC RULES (STANDARD EC) NORMAS DE LA CE

Direttiva Basso Voltaggio  
Low Voltage Directive  
Directiva de baja tensión } **2014/35/UE**

Direttiva EMC Compatibilità Elettromagnetica  
EMC electromagnetic compatibility directive  
EMC directiva de compatibilidad electromagnética } **2014/30/UE**

Norme armonizzate europee nell'ambito della direttiva  
European harmonized standards underdirective  
Las normas europeas armonizadas conforme a la directiva } **2006/42/CE**



VMS metering pump is tested and certified by WQA to NSF/ANSI 50 and 61 for materials safety.

## GENERAL SAFETY GUIDELINES

Operating, installing, or maintaining the unit in any way that is not covered in this manual could cause death, serious personal injury, or damage to the equipment.

### ICON

This manual use the following safety message icon:



#### **Danger!**

Indicates a hazardous situation which, if not avoided, will result in death or serious injury.



#### **Warning!**

Indicates a hazardous situation which, if not avoided, could result in death or serious injury.



**Important** - A practice not related to personal injury or additional information.



**Cross reference** - An instance which refers to related information elsewhere in the same document

**METERING PUMP IS INTENDED FOR CHEMICAL DOSING AND DRINKING WATER TREATMENT.**

Do not use in explosive area (EX).  
Do not use with flammable chemicals.  
Do not use with radioactive chemicals.

Use after a proper installation.

Use the pump in accordance with the data and specifications printed on the label.

Do not modify or use in a manner inconsistent with the provisions of the operating manual.



**Keep the pump protected from sun and water. Avoid water splashes.**



**In emergencies the pump should be switched off immediately. Disconnect the power cable from the power supply.**



**When using pump with aggressive chemicals observe the regulations concerning the transport and storage of aggressive fluids.**



**When installing always observe national regulations.**



**Manufacturer is not liable for any unauthorized use or misuse of this product that may cause injury, damage to persons or materials.**



**Pump must be accessible at all times for both operating and servicing. Access must not be obstructed in any way.**



**Feeder should be interlocked with a no-flow protection device.**



**Pump and accessories must be serviced and repaired by qualified and authorized personnel only.**



**Before any operation:**

- always read chemical Material Safety Data Sheet (MSDS);
- always wear protective clothing;
- always discharge the liquid end before servicing the pump.
- empty and rinse the liquid end before work on a pump which has been used with hazardous or unknown chemicals.



**This equipment requires regular maintenance to ensure potability requirements of the water and maintenance of improvements as declared by the manufacturer.**

**ENVIRONMENTAL SAFETY**

**Work area**

Always keep the pump area clean to avoid and/or discover emissions.

**Recycling guidelines**

**EWC code: 16 02 14**

Always recycle according to these guidelines:

1. If the unit or parts are accepted by an authorized recycling company, then follow local recycling laws and regulations.
2. If the unit or parts are not accepted by an authorized recycling company, then return them to the nearest representative.

**Waste and emissions regulations**

Observe these safety regulations regarding waste and emissions:

- Dispose appropriately of all waste.
- Handle and dispose of the dosed chemical in compliance with applicable environmental regulations.
- Clean up all spills in accordance with safety and environmental procedures.
- Report all environmental emissions to the appropriate authorities.

**LABELS**

Fig. 1. Product label.

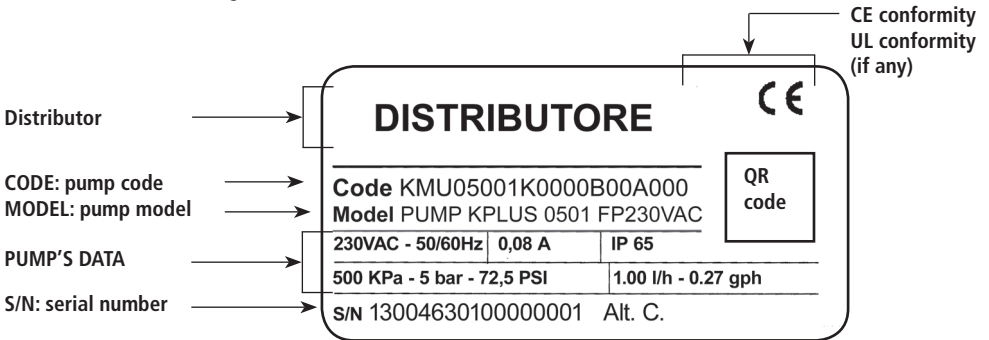

**Spare parts**

For spare parts orders or any other communication, refer to product label. Code (CODE) and serial number (S / N) uniquely identify the pump.

Fig. 2. WQA label.



**THIS METERING PUMP IS TESTED AND CERTIFIED BY WQA TO NSF/ANSI 50 AND 61 FOR MATERIALS SAFETY.**

# 1. Introduction

Introduction:

Metering Pumps "VMS MF" Series are the ideal solution for low / middle dosing of chemicals. All control and setup parameters are available through a digital keyboard and they are displayed on a LCD backlit display. Pump has "Level" input ,

Pump's capacity

Flow rate is determined by the stroke speed (frequency) adjustment.

However dosing accuracy is guarantee within an adjustment range from 30% to 100%.

Working modes:

Pump can work in differents ways. See related chapters for extended description of each single mode.

## **CONSTANT mode.**

Pump doses at a constant rate set in "SPH" (strokes for hour), "SPM" (strokes for minute) or "LPH" (litres per hour) parameters set during program session.

## **DIVIDE mode.**

External pulses from a water meter are divided by a value set during program session. The pump doses with a rate determined by this parameter.

## **MULTIPLY mode.**

External pulses from a water meter are multiplied by a value set during program session. The pump doses with a rate determined by this parameter.

## **PPM mode.**

Dosing rate is determined by pulses from a water meter on the base of set PPM, chemical product concentration (%) and quantity for each single stroke set during program session.

## **PERC mode**

Dosing rate is determined by pulses from a water meter on the base of set PERC (%), chemical product concentration (%) and quantity for each single stroke set during program session.

## **MLQ mode**

Dosing rate is determined by pulses from a water meter on the base of set MLQ (milliliters per quintal), chemical product concentration (%) and quantity for each single stroke set during program session.

## **BATCH mode.**

Signal from an external contact starts the pump to dose the set quantity.

## **VOLT mode.**

Voltage from an external device drives the pump that doses proportionally using a minimum and maximum of strokes for minute set during program session (0 ÷ 10 VDC).

## **mA mode.**

Current from an external device drives the pump that doses proportionally using a minimum and maximum of strokes for minute set during program session

## 2. Unpacking

Included into package:



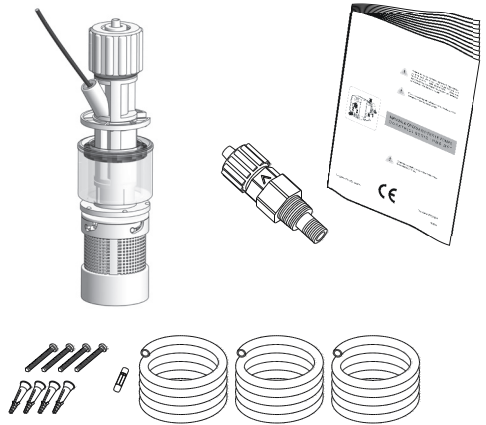

- n.4 Dibbles ø6
- n.4 Self tapping screws 4,5 x 40
- n.1 Delayed fuse 5 X 20
- n.1 Foot filter with valve
- n.1 Injection valve
- n.1 Level probe
- m 2 Delivery pipe\* (opaque PE)
- m 2 Suction pipe \* (transparent PVC)
- m 2 Discharge pipe (transparent PVC)
- n.1 This installation manual

\* If hose is 6x8 there is only a 4meters long hose.  
Cut to obtain suction and delivery hoses.

  
**PLEASE DO NOT TRASH  
PACKAGING.  
IT CAN BE USED TO RETURN  
THE PUMP.**



Legend:

- a. Alternating Current; 
- b. DC, 
- c. Protective Earth; 
- d. Standby; 
- e. Warning - 

### 3. Pump's description

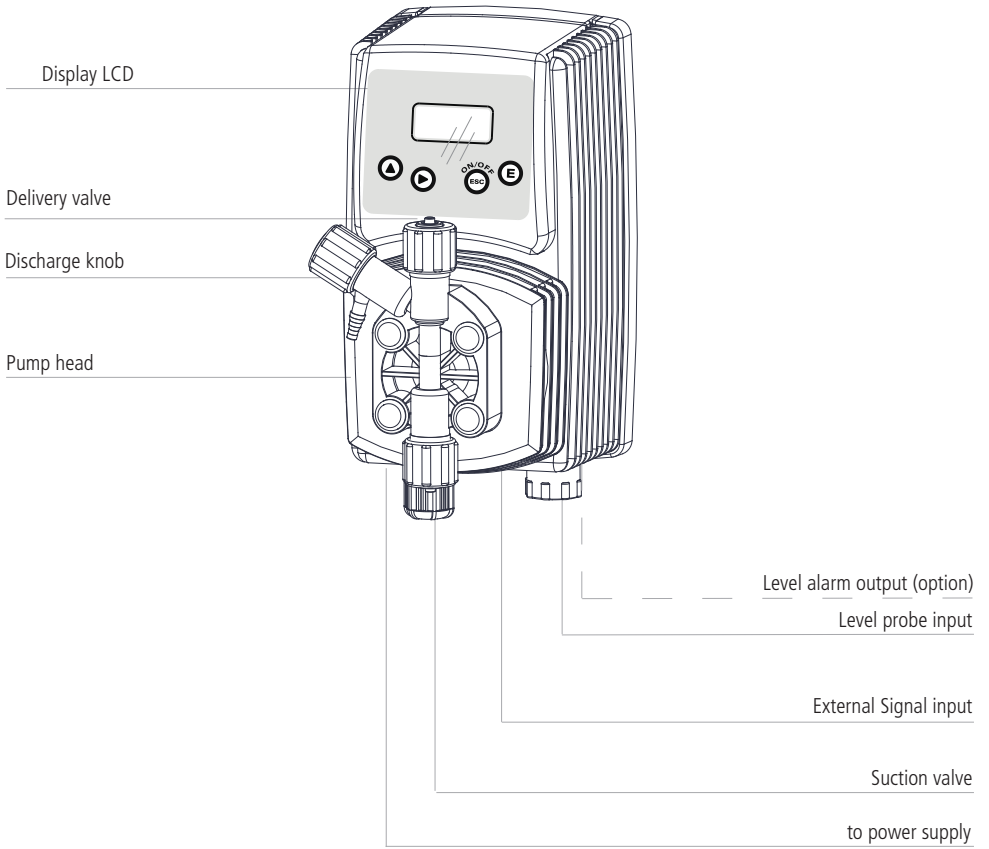

## 4. Before to Install warnings

Pump's installation and operativity is made in 4 main steps:

- Pump's installation
- Hydraulic Installation (hoses, level probe, injection valve)
- Electrical Installation (main power connection, priming)
- Programming the pump.

Before to start, please read carefully the following safety information.

### Protective clothes



Wear always protective clothes as masks, gloves, safety glasses and further security devices during ALL installation procedure and while handling chemicals.

### Installation location



Pump must be installed in a safety place and fixed to the table / wall to avoid vibration problems!

Pump must be installed in a easy accessible place!

Pump must be installed in vertical position!

Avoid water splashes and direct sun!

### Hoses and Valves



Suction and delivery hoses must be installed in vertical position!  
All hoses connections must be performed using only hands' force!  
No tongs required!

**Delivery hose must be firmly fixed to avoid suddenly movements that could damage near objects!**

**Suction hose must be shorter as possible and installed in vertical position to avoid air bubbles suction!**

Use only hoses compatibles with product to dose! See chemical compatibility tabl.  
If dosing product is not listed please consult full compatibility table or contact chemical's manufacturer!



**Feeder should be interlocked with a no-flow protection device to automatically shut-off the pumps when there is no flow!**



**Adequate measures shall be taken to prevent cross connection of chemicals!**



**Chemical feeding must be stopped during backwash cycles and periods of no-flow as these conditions may introduce the potential for chemical overdosing. Not doing so may result in elevated chemical concentrations and hazerdous gas introduction into the pool or spa.**



## 5. Installation Draw

Pump must be installed in a wall support at a maximum height (**from tank's bottom**) of **1,5 meters**.

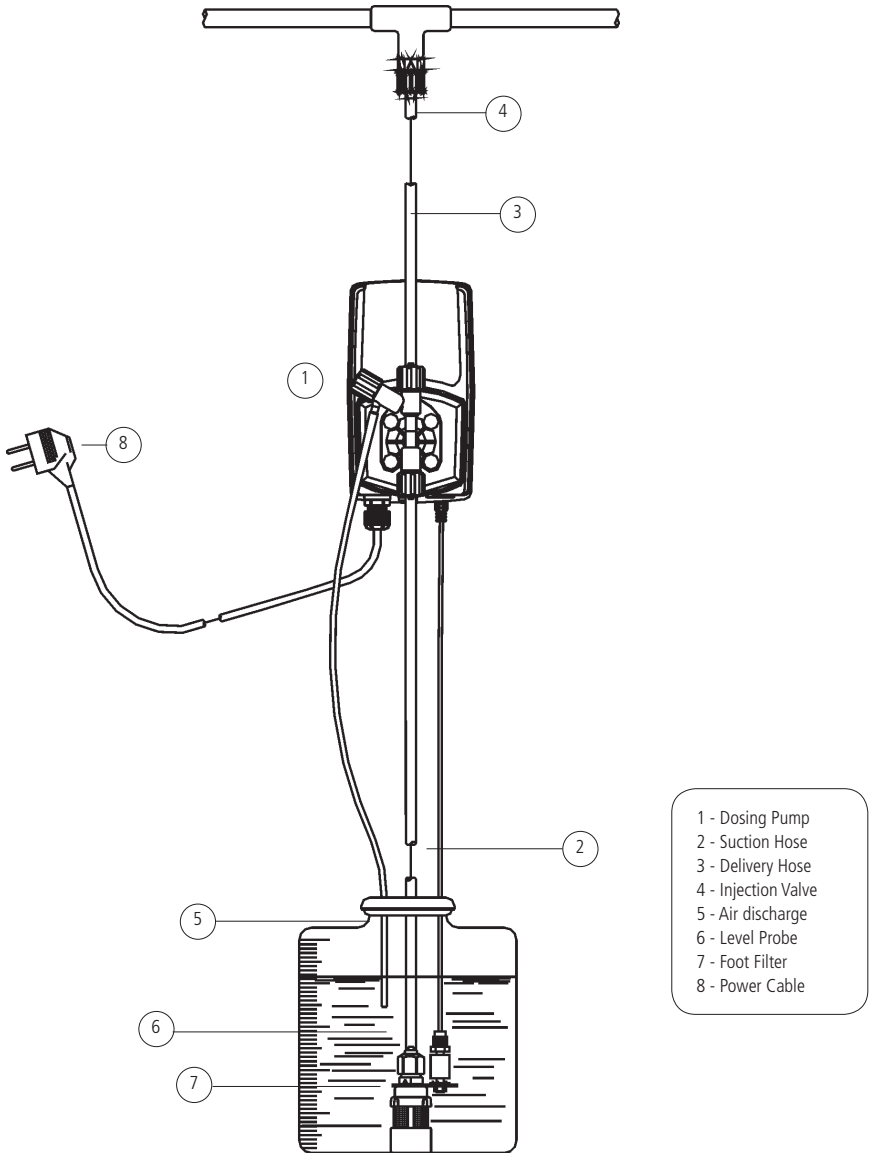

## 6. Hydraulic Installation

Hydraulic connections are:

Suction Hose with level probe and foot filter  
Delivery Hose with injection valve  
Discharge Hose

### Suction Hose.

Completely unscrew tightening nut from pump's head and remove assembling components: tightening nut, holding ring and pipe holder.

Assembly as shown in fig. (A). Insert hose into pipe holder until it reaches the bottom.

Lock hose on pump's head by screwing down the tightening nut.  
Use only hands to do it!

Connect other side of the hose to the foot filter using the same procedure.



fig. (A)

### Assembling foot filter with level probe.

Level probe must be assembled with foot filter using the provided kit.  
Foot valve is made to be installed into tank's bottom without sediments priming problem.

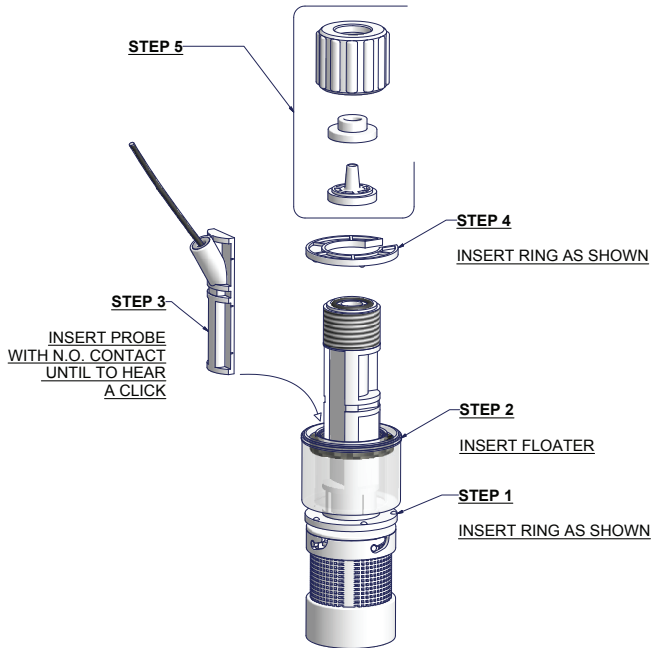

Connect BNC from level probe into pump's level input (front side of the pump).  
Put level probe assembled with foot filter into tank's bottom.

**Warning: If there is a mixer installed into tank, install a suction lance instead of level probe / foot filter.**

### Delivery Hose.

Completely unscrew tightening nut from pump's head and remove assembling components: tightening nut, holding ring and pipe holder.

Assembly as shown in fig. (A). Insert hose into pipe holder until it reaches the bottom.

Lock hose on pump's head by screwing down the tightening nut.  
Use only hands to do it!

Connect other side of the hose to the injection valve using the same procedure.

**Discharge hose.**

Insert one side of discharge hose into discharge connector as shown in fig (C).

Insert other side of discharge hose into product's tank.  
During priming procedure product exceeding will flow into tank.

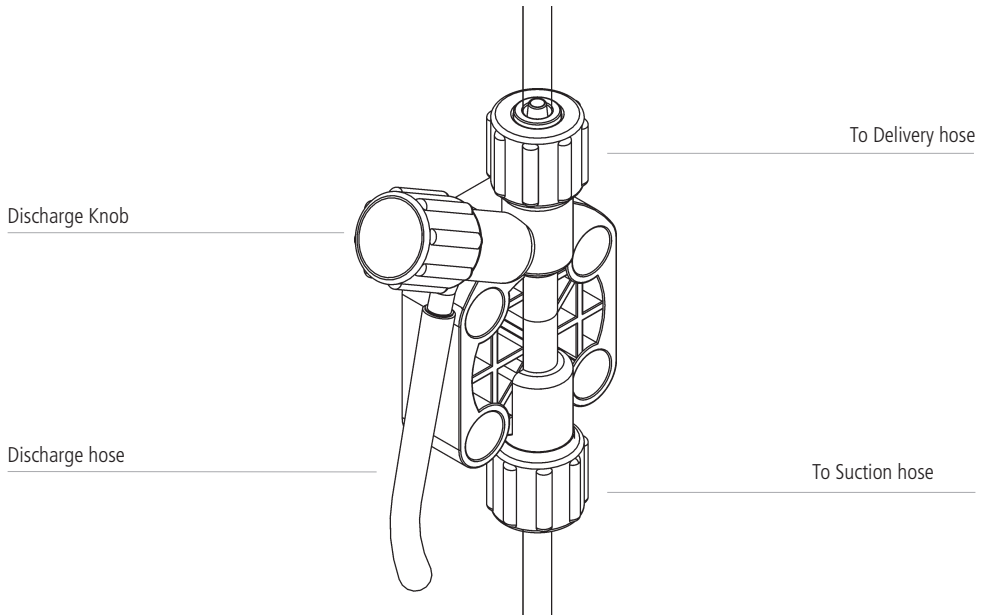
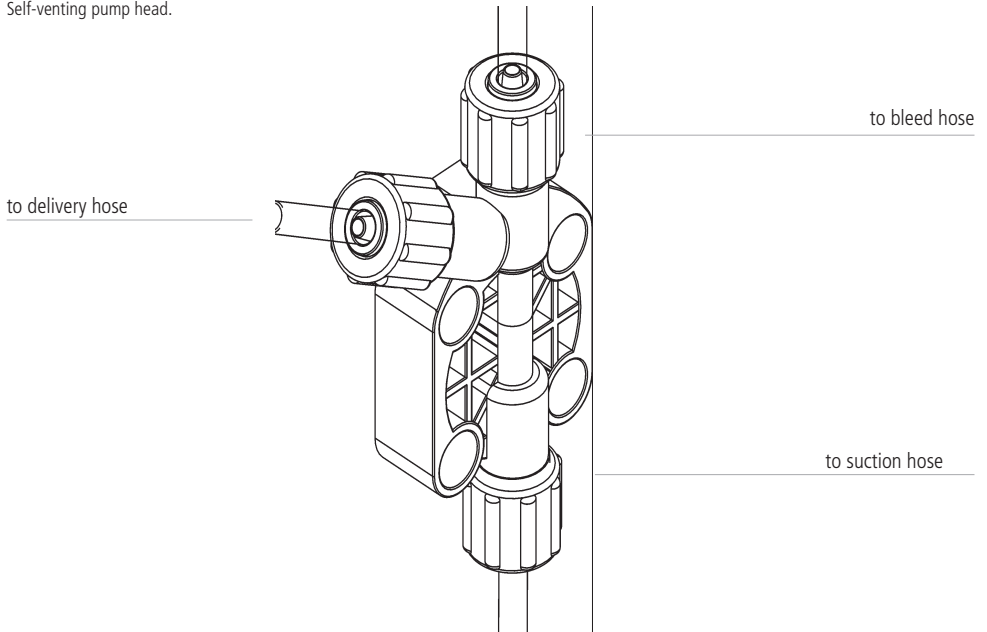

fig (C)

For priming procedure see page 14.

Self-venting pump head.



Self-venting pump head must be used when using chemicals that produce gas (i.e. hydrogen peroxide, ammonium, sodium hypochlorite at particular conditions).

Hoses assembling procedure (including purge hose) is described in fig. (A).

**Notes:**

- suction, delivery and purge valves are DIFFERENT! Do not exchange them!
- delivery and purge hoses are made of same material!
- it's allowed to lightly bend discharge hose!
- during calibration procedure ("TEST") insert discharge hose into BECKER test-tube!

## 7. Electrical Installation

All electrical connections must be performed by **AUTHORIZED AND QUALIFIED** personnel only.  
Before to proceed, please, verify the following steps:

- verify that pump's label values are compatible with main power supply.
- pump must be connected to a plant with a differential switch (0,03A sensitivity) if there isn't a good ground.
- to avoid damages to the pump do not install it in parallel with heavy inductance load (for example: engines). A relay switch must be used. See below picture.

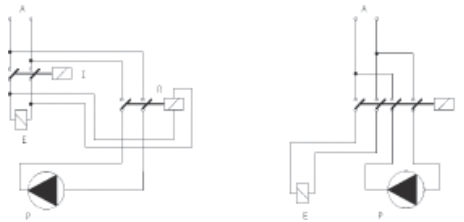

**P** - Dosing Pump  
**R** - Relay  
**I** - Switch or safety device  
**E** - Electrovalve or inductance load  
**A** - Main Power



WARNING

IF EQUIPMENT IS SUPPLIED WITH A PLUG:

If an appliance coupler or separable plug is used as the disconnecting device, it shall be readily identifiable and easily reached by the operator.  
For single-phase portable equipment, a plug on a cord of length not greater than 3m is considered to be easily reached.



WARNING

IF EQUIPMENT IS NOT SUPPLIED WITH A PLUG:

- a) a switch or circuit-breaker shall be included in the building installation
- b) it shall be in close proximity to the equipment and within easy reach of the operator
- c) it shall be marked as the disconnecting device for the equipment

Once verified previous steps proceed as follows:

- check that "BNC" of level probe has been connected as described in "Hydraulic Installation" chapter.
  - connect "BNC" and external signal to pump's "INPUT": -braided shield cable; +center conductor
- This input may be used as follows:
- as pulse sender water meter or
  - as startup contact for "BATCH" mode or
  - as voltage input for "VOLT" mode or
  - as current input for "mA" mode

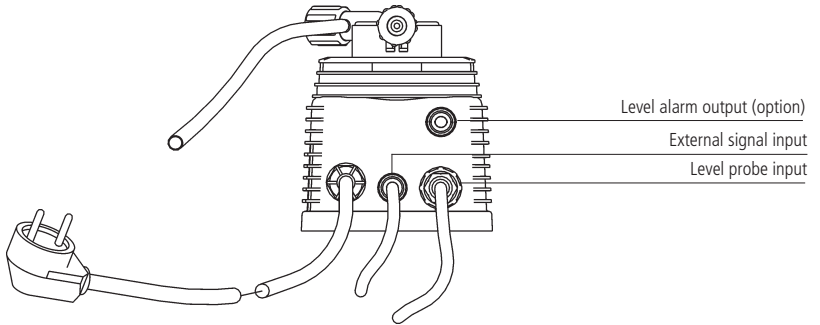

#### **LEVEL ALARM OUTPUT (option)**

If present, connect the red/black wire.  
Free of voltage contact not protected by fuse.  
Max load: 1A 115 VAC.

#### **PUMPS WITH PULSE EMITTER WATER METER WITH HALL EFFECT (NPN sensor)**

External signal has got a three-wires connection:

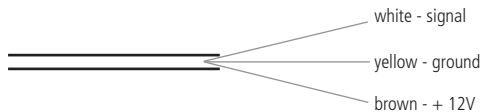

If the pulse emitter water meter is supplied with metering pump external signal will be an MPM connector for water meter connection. For main board connection see on page 46.

## 8. Basic Settings

LCD backlit display

Scroll and increase digit

Turn the pump on or off and exit from setup menu (without saving parameters)

Enter / exit from setup menu (saving parameters)

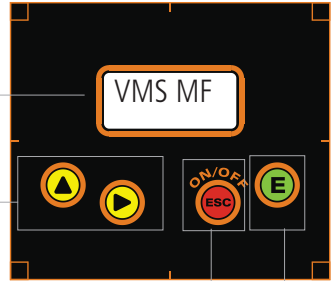

The "VMS MF" pump is equipped with a keyboard. To avoid any misunderstanding during next chapters all keys will be described as shown on this legend:



"UP" key

ON/OFF



"ESC" key



"RIGHT" key



"E" key

### Menu navigation:

To enter into programming mode press and keep pressed "E" key from main screen (fig.3):



fig.3

Main screen (fig.3) may appear different if "PPM" or "BATCH" mode is enabled. After about 4 seconds the pump will show the password screen (fig.5):

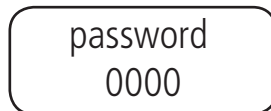

fig.5

Default password is "0000". Just press "E" key. Otherwise insert password using "UP" and "RIGHT" keys.



### **Saving / Discarding changes / Activating working mode**

Once edited data into setup menu it's possible to save them by pressing "E" key or to discard them by pressing "ESC" key.

To activate a working mode (Constant, Divide, Multiply, PPM, PERC, MLQ, Batch, Volt, mA) select the required mode and confirm it using "E" key.

### **Turning on and off the pump**

"ESC" key has a double function. It can be used to discard all changes made into setup mode or to turn on/off the pump. To turn on/off the pump press and keep pressed this key while in main screen (fig.3). The pumps will show:

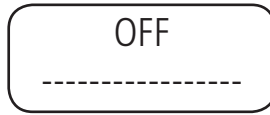

To return into operating mode press "ESC" key.

fig.6

### **Full menu / Short Menu mode**

When entering into SETUP display shows access mode menu:

If this is the first time into SETUP menu then the pump will automatically set itself into "FULL" menu mode as shown in fig. A. Just press "E" key to confirm. This mode will show all pump functions and working modes.



fig. A



fig. B

Next time the SETUP menu will be reached it will possible to operate with "SHORT" menu configuration to change only selected mode parameters as shown in fig. B. Press "E" to confirm.

**Note: "SHORT" menu option is not available during first time into SETUP menu or after a reset.**

## 9. Priming

### PRIMING

To proceed follow these steps: connect all hoses to the pump; open discharge valve by completely turning the discharging knob (counter clock-wise). Power up the pump.

After pump's intro (fig.1):

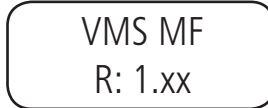
A rounded rectangular box containing the text "VMS MF" on the top line and "R: 1.xx" on the bottom line.

VMS MF  
R: 1.xx

fig.1

the pump will show the "Delay" (pump's activation delay) as shown fig.2:

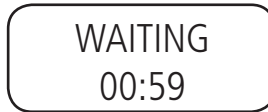
A rounded rectangular box containing the text "WAITING" on the top line and "00:59" on the bottom line.

WAITING  
00:59

fig.2

Press any key to skip the "Delay". Pump will show "Strokes" (actual strokes) as shown in fig.3:

A rounded rectangular box containing the text "STROKES" on the top line and "100 SPM" on the bottom line.

STROKES  
100 SPM

fig.3

Press and keep pressed the "RIGHT" key to enter into priming mode. Pump will go for 30 seconds into priming mode as shown in fig.4.

A rounded rectangular box containing the text "PRIMING" on the top line and "30 Sec." on the bottom line.

PRIMING  
30 Sec.

fig.4

When the chemical begins to flow out from the outgassing hose then completely close the outgassing knob (except for self-venting pump heads). This ends the priming procedure. If countdown for priming is not yet ended press "ESC" key.

**Now the pump is operative. Proceed to setup and programming.**

## 10. Pump's functions summary

### Pump's functions summary

During pump's working mode is it possible to see further working information.  
Press more times the "UP" key to cycle through following information:

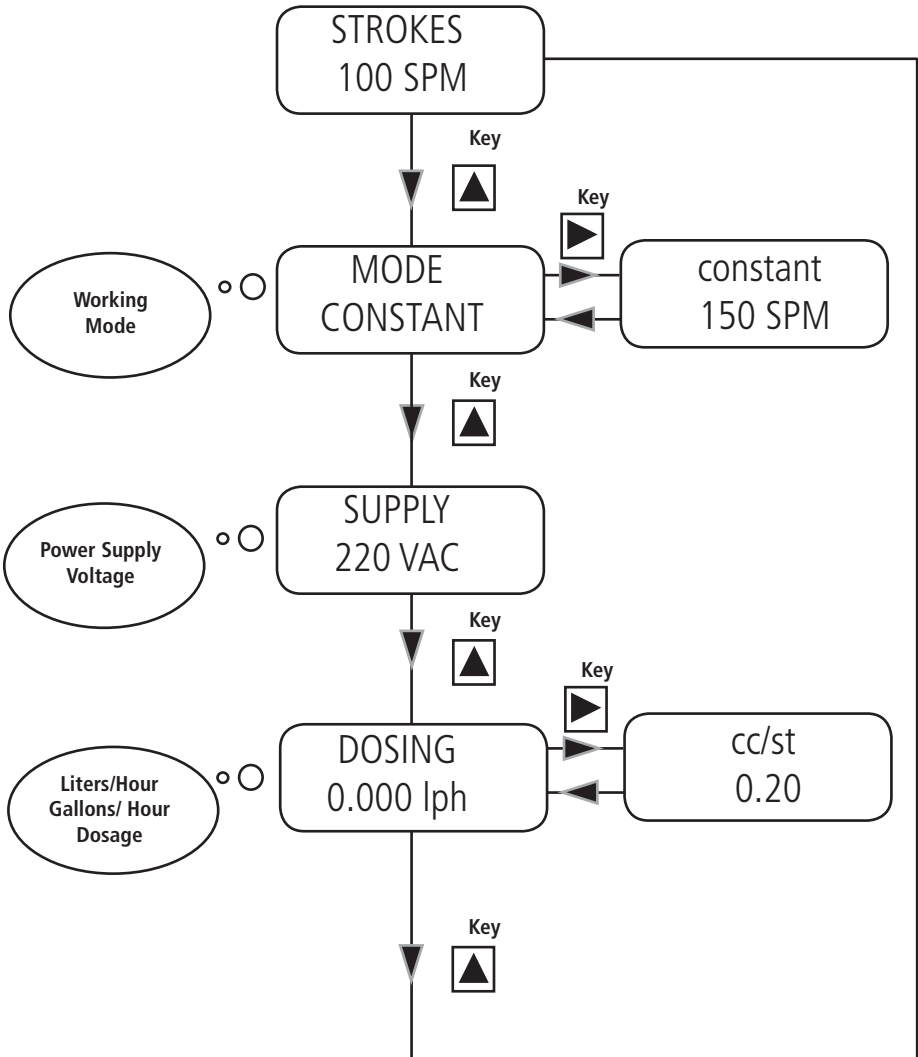

## 10. Pump's functions summary- ALARMS

If any alarm is active, in the menu "Pump's functions summary" a general alarm display will show the symbol "#" and the number of alarm active at the moment. Enter into this menu with "RIGHT" key. The windows displayed show which alarms are active.

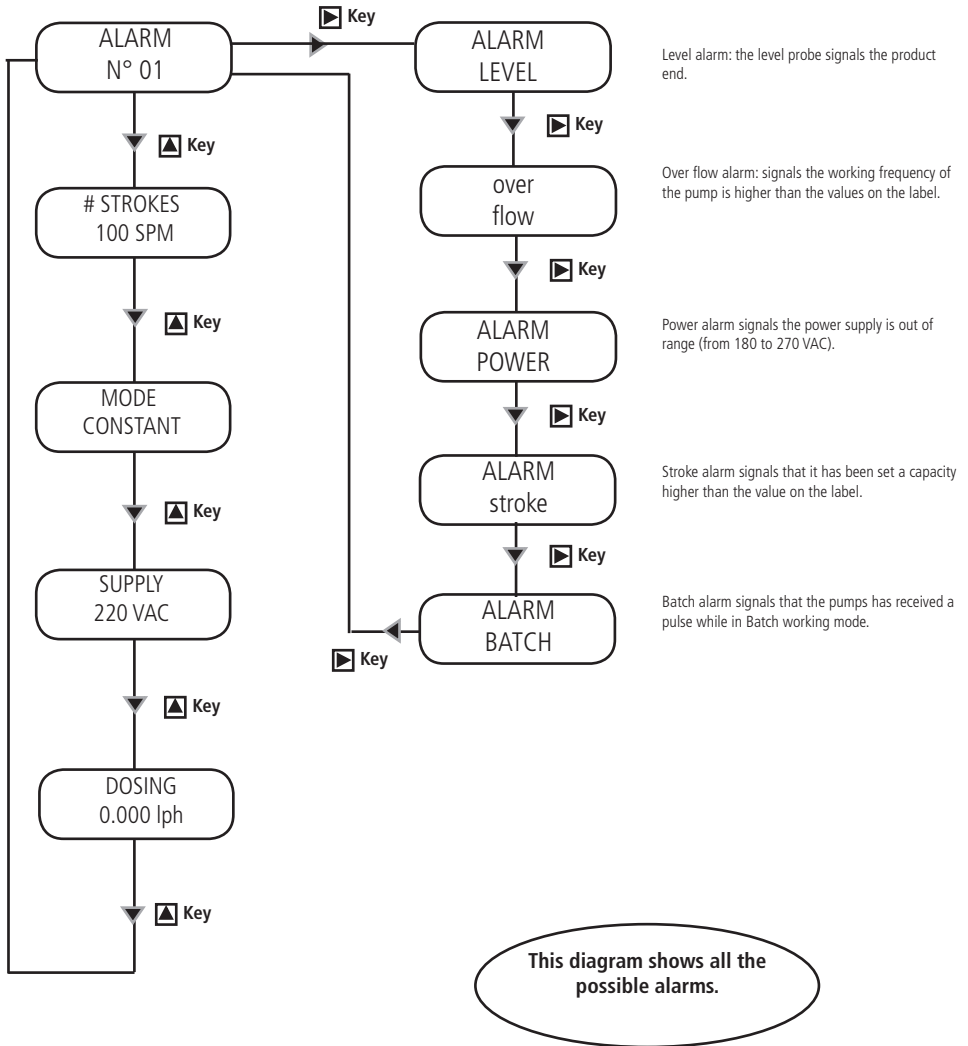

# 11. Quick Guide - Main Menu (Prog [1] Mode)

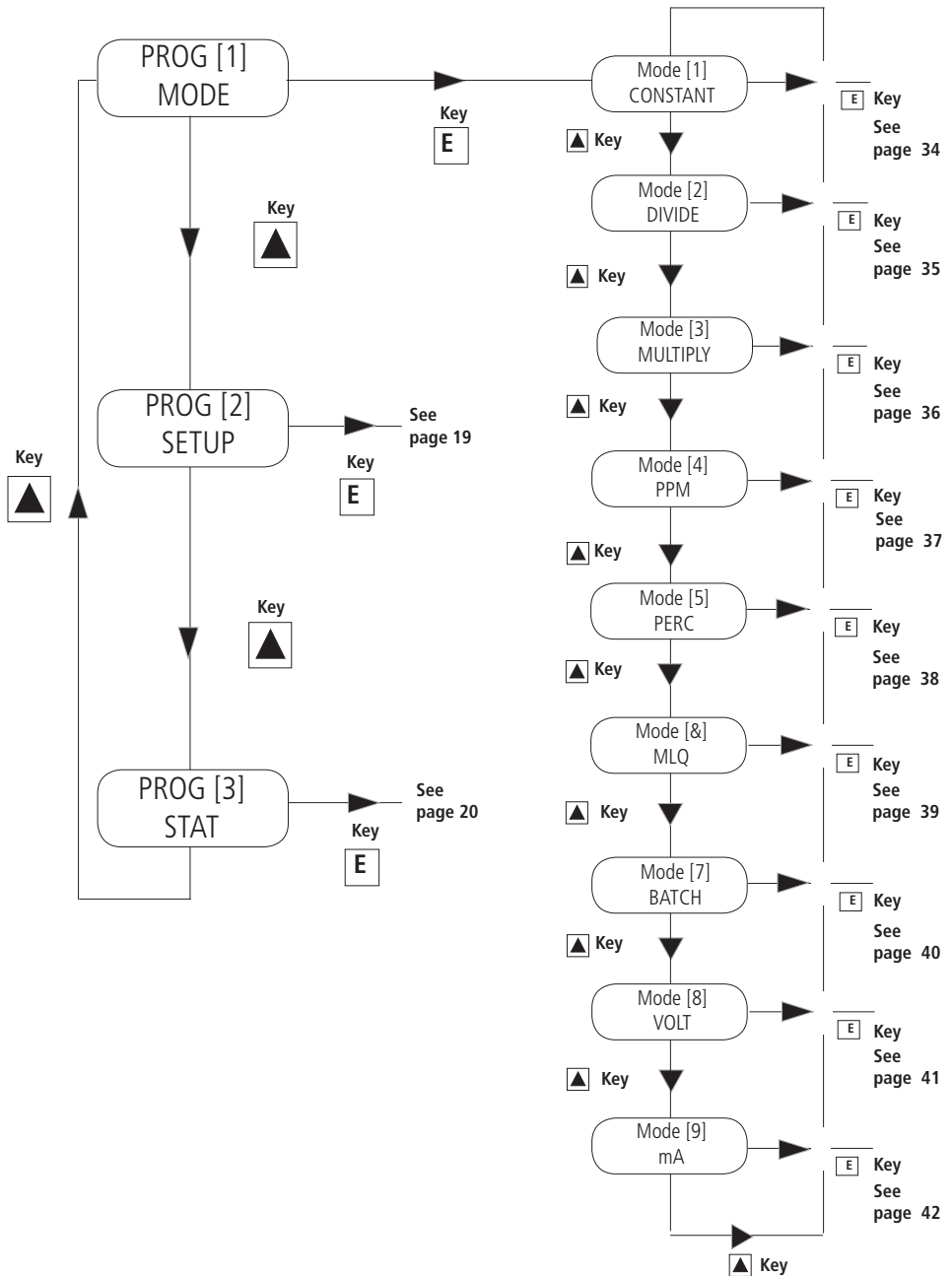

## 12. Quick Guide - Main Menu (Prog [2] Setup)

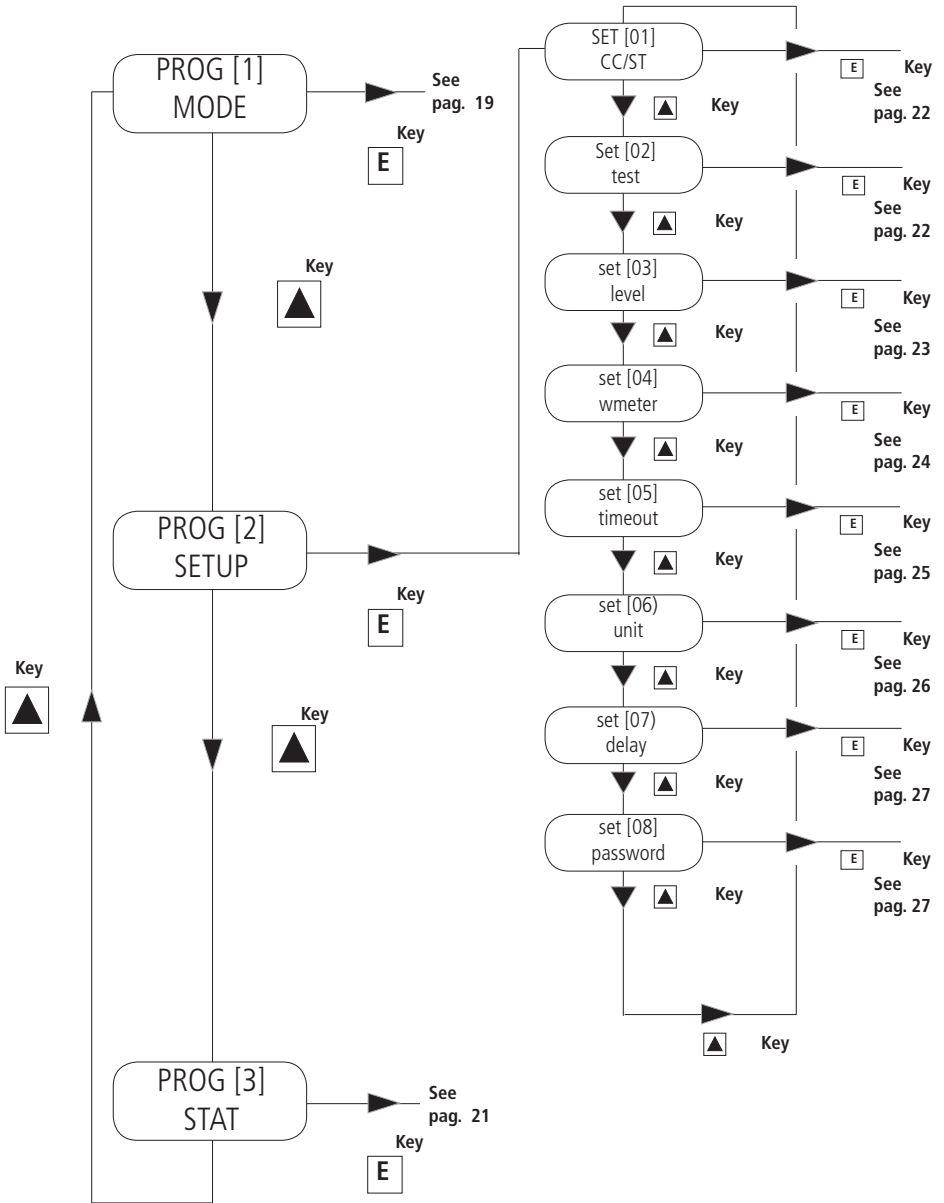

13. Quick Guide - Main Menu (Prog [3] Stat)

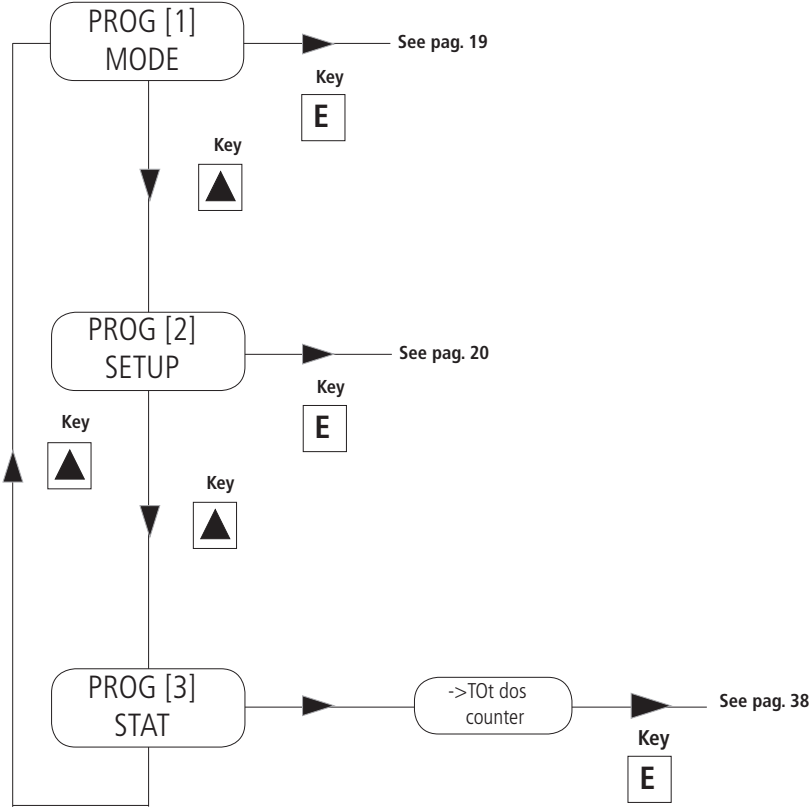

## 15. Setup

### Pump's initial setup

Apart of chosen working mode, the pump must be prepared to operate by setting the main parameters into "SETUP" menu. To enter into this menu please follow the "Quick Guide through menu" at page 20.

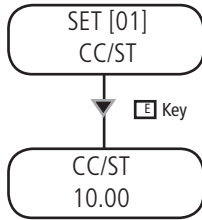

CC per Stroke.

Enter here the cc/stroke value obtained during "Test" mode (calibration).

Use "UP" key to increase of one unit the blinking digit "\_".

Press "RIGHT" key to skip on next digit.

Press "E" key to save data and "ESC" exit to main menu.

Otherwise press "ESC" to discard data and exit to main menu.

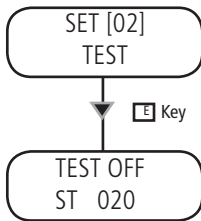

Calibration.

This procedure defines the cc quantity (cubical centimeters) that the pump feed every single injection. To determine this value the pump must be calibrated.

1) Install the pump on plant and insert the suction hose (with its level probe / foot filter) into a BEKER "test-tube". If pump's model is self-priming put the discharge hose into the "test-tube" too.

2) Power up the pump and turn the flow's knob to required position.

3) Fill up the "test-tube" with the chemical until to reach a known value.

4) From setup menu choose "TEST", and insert "20". This value is the strokes that the pump will produce during the procedure.

6) Press "E". The pump will begin to produce the 20 strokes and to suck the chemical from the "test-tube".

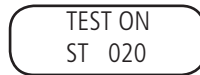

7) At the end of 20 strokes the pump will stop. Read the value of chemical left into "test-tube".

8) Subtract the initial value to the left value.

9) Divide the result with the ST value (20).

10) Type this value into "CC/ST" (Set [01]) as previously described.

11) If obtained result is too small or too big, please, try to change strokes value (20).

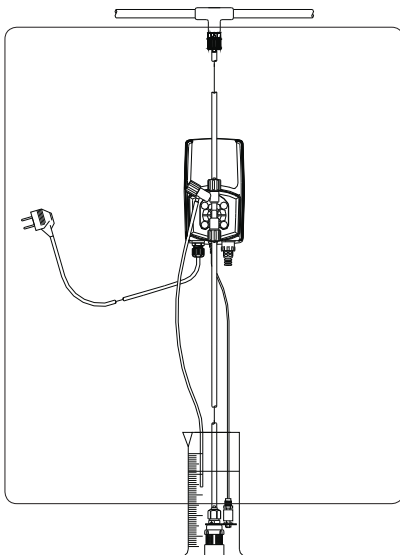



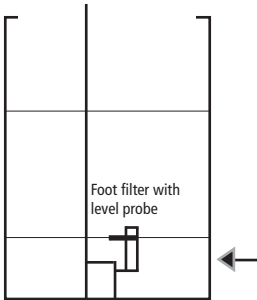
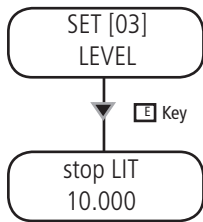

Customizable Reserver (liters / gallons)

Pre Level Alarm (Reserve).

This function defines a pre-alarm status to inform user that the dosing product is near to end. Reserve value to be set, must be calculated on product quantity left between foot filter and pump's suction level.

- Use "UP" key to increase the blinking "\_" digit.
- Press "RIGHT" key to skip on next digit.
- Press "E" key to save data and "ESC" exit to main menu.

Otherwise press "ESC" to discard data and exit to main menu.

During the alarm the pump continues to dose but it'll show the following picture:

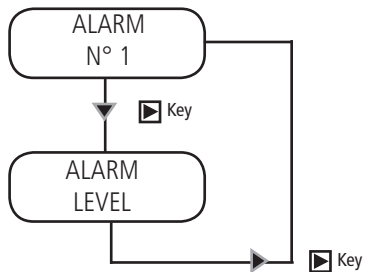

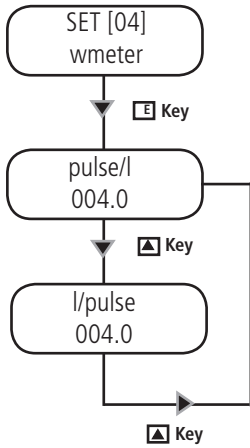

#### Water Meter Setup.

Use this function to setup the water meter information.

By entering the amount of pulses produced by the water meter the pump will optimize the working mode when programmed to work in ppm and update the stats menu.

- Use "UP" key to choose from "Pulse/L" (pulse/liter) or "L/Pulse" (liter/pulse).

Choose "Pulse/L" for a water meter that produces many pulses.

Choose "L/Pulse" for a water meter that produces few pulses.

Setting "000.0", the pump does not accept the signal and it is not possible to save the data.

- Use "UP" key to increase the blinking " " digit. Enter number of pulses that pump must receive to stop or not the pump.

- Press "RIGHT" key for next digit / field.

- Press "E" key to save data and "ESC" to exit to main menu. Otherwise press "ESC" to discard data and exit to main menu.

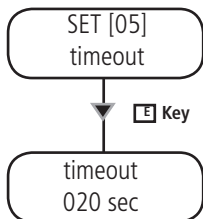

Pulses Timeout (only for "Multiply" working mode and "PPM", "PERC" and "MLQ" working mode when the result is a multiplication).

When the pump receives a pulse from the water meter it starts the dosing activity through an amount of time (from the first pulse to the following one). At the beginning the pump doesn't know the time lapse between the first and the second pulse. So it'll dose the product in the fastest way. From the second pulse, the pump will dose the product correctly.

This function set the maximum time between a pulse and the following one. Once that this time is exceeded the pump will reinitialize the dosing activity as the first time that a pulse has been received.

Default value is 120 seconds.

To set "Timeout" function, between the minimum (1 sec.) and the maximum (999 sec.), proceed as follow:

- Use "**UP**" key to increase the blinking " \_ " digit. stop or not the pump.
- Press "**RIGHT**" key for next digit / field.
- Press "**E**" key to save data and "**ESC**" to exit to main menu. Otherwise press "**ESC**" to discard data and exit to main menu.

Pulses Timeout does not take part in "Divide" working mode and in all working modes when the result is a division.

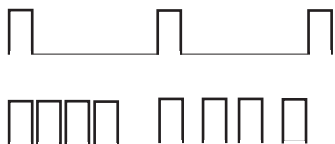

External Pulses

The first time that the pump receives a pulse it doesn't know the time between this pulse and the following one. So the pump will run faster as possible. "Timeout" function forces the pump to work in this way, once a specified amount of time has been exceeded.

After second pulse the pump will know the time between a pulse and the following one.

So it'll dose optimizing the dosage through the time.

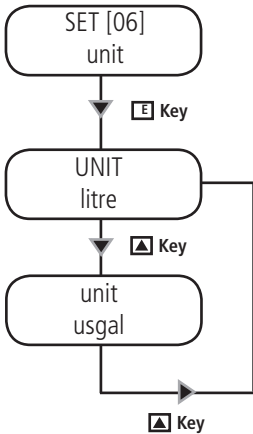

#### Unit Change.

This function allows to choose between liters or gallons measurement unit.

- Use **"UP"** key to switch between liter or gallons measurement unit.
- Press **"E"** key to save data and **"ESC"** exit to main menu. Otherwise press **"ESC"** to discard data and exit to main menu.

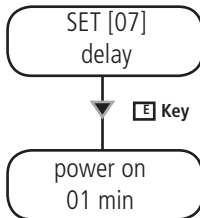

#### Startup Delay Setup.

When the pump is powered is it possible to have a delay time (from 0 to 10 minutes) before dosing activities.

- Use **"UP"** key to choose the alarm to set.
- Use **"RIGHT"** key for next digit.
- Press **"E"** key to save data and **"ESC"** exit to main menu. Otherwise press **"ESC"** to discard data and exit to main menu.

Note: Press any key during delay time to skip it.

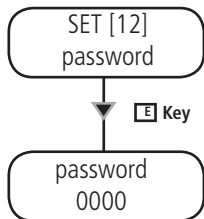

#### Password Setup.

"Setup" menu is password protected. Default value to enter into "setup" menu is "0000" (only numeric units). To change this password proceed as follows:

- Use **"UP"** key to change first digit.
- Press **"RIGHT"** key to move cursor over next digit.
- Press **"E"** key to save data and **"ESC"** to exit to main menu. Otherwise press **"ESC"** to discard data and exit to main menu.

Note: For lost password, please, follow the "Load default" procedure.

## 16. "Load default" and "Reset Password" procedure

### **"LOAD DEFAULT" procedure**

This procedure deletes all programming data set. It reloads the default data of the pump.

Follow this instructions:

- unplug power supply;
- pressing both "UP" and "RIGHT" keys, plug in power supply.

For few seconds, the display shows LOAD DEFAULT before start up the pump.

### **"RESET PASSWORD" procedure**

This procedure resets the password set and reloads the default password of the pump ("0000").

Follow this instructions:

- unplug power supply;
- pressing both "UP" and "ESC" keys, plug in power supply.

For few seconds, the display shows RESET PASSWORD before start up the pump.

## 17. Working procedure setup

### Introduction.

"MF" pump can work in different modes.

#### CONSTANT mode.

Pump doses at a constant rate set in "SPH" (strokes for hour), "SPM" (strokes for minute) or "LPH" (litres per hour) parameters set during program session.

##### When to use this mode ?

This mode is useful when there isn't an input signal to control the dosing activity. Pump doses requested product quantity in constantly.

##### Which parameters must be set ?

SPH (strokes per hour), SPM (strokes per minute) LPH (litres per hour)

#### DIVIDE mode.

External pulses from a water meter are divided by a value set during program session. The pump doses with a rate determined by this parameter.

##### When to use this mode ?

This mode is useful using an external signal from a pulse sender water meter that produces elevated quantities of pulses. Pump divides these pulses to allow a correct dosing activity.

##### Which parameters must be set ?

DIVIDE (division factor)

#### MULTIPLY mode.

External pulses are multiplied by a value set during program session. The pump doses with a rate determined by this parameter.

##### When to use this mode ?

This mode is useful using an external signal from a pulse sender water meter that produces low quantities of pulses. Pump multiplies these pulses to allow a correct dosing activity.

##### Which parameters must be set ?

MULTIPLY (multiply factor)

#### PPM mode.

Dosing rate is determined by pulses from a water meter, desired concentration in PPM, chemical product concentration (%) and quantity for each single stroke set during program session.

##### When to use this mode ?

This mode is useful using an external signal from a pulse sender water meter and it's necessary to specify only PPM (parts per million) and product concentration, leaving the pump to manage coming pulses.

##### Which parameters must be set ?

PPM (parts per million product quantity)  
CONC (% of product's concentration)  
Water Meter Pulses  
CC/Stroke

**PERC mode.**

Dosing rate is determined by pulses from a water meter, percentage (%), chemical product concentration and quantity for each single stroke set during program session.

**When to use this mode ?**

This mode is useful using an external signal from a pulse sender water meter and it's necessary to specify only % , leaving the pump to manage coming pulses.

**Which parameters must be set ?**

% (percentual product to dose)  
CONC (percentual of product concentration)  
Water Meter Pulses  
CC/STROKE  
TIMEOUT

**Water meter:**

Use a water meter to reach its maximum pulsating capabilities.

Note: maximum frequency for this pump is 1Khz (1000 pulses per second).



**MLQ mode.**

Dosing rate is determined by pulses from a water meter on the base of set MLQ (milliliters per quintal), chemical product concentration (%) and quantity for each single stroke set during program session.

**When to use this mode ?**

This mode is useful when with an external signal from a pulse sender (as a water meter), it is necessary to dose the product quantity set specifying the MLQ (milliliters per quintal) and leaving the pump to manage the coming pulses.

**Which parameters must be set ?**

MLQ (product quantity in milliliters per quintal)  
CONC (% of product's concentration): set 100% if product is pure  
Water Meter Pulses  
CC/Stroke  
TIMEOUT

**BATCH mode.**

Signal from an external contact starts the pump to dose product or to produce an amount of strokes set during program session.

**When to use this mode ?**

This function allows to begin dosing activities when pump receives an external signal.

**Which parameters must be set ?**

ST (strokes)  
CC (product's quantity to dose)

**VOLT mode.**

Voltage from an external device drives the pump that doses proportionally using a minimum and maximum of strokes for minute set during program session.

**When to use this mode ?**

This mode is used with controllers provided of a proportional output in voltage.

**Which parameters must be set ?**

HIV (maximum tension)  
LOV (minimum tension)  
SPM (strokes per minute)

**mA mode.**

Current from an external device drives the pump that doses proportionally using a minimum and maximum of strokes for minute set during program session.

**When to use this mode ?**

This mode is used with controllers provided of a proportional output in current.

**Which parameters must be set ?**

HImA (maximum current)  
LOmA (minimum current)  
SPM (strokes per minute)

## 18. "CONSTANT" working mode

### CONSTANT mode.

Pump doses at a constant rate set in "SPH" (strokes for hour), "SPM" (strokes for minute), "LPH" (litres per hour) parameters set during program session.

#### Which parameters must be set ?

SPH (strokes per hour), SPM (strokes per minute), LPH (litres per hour).

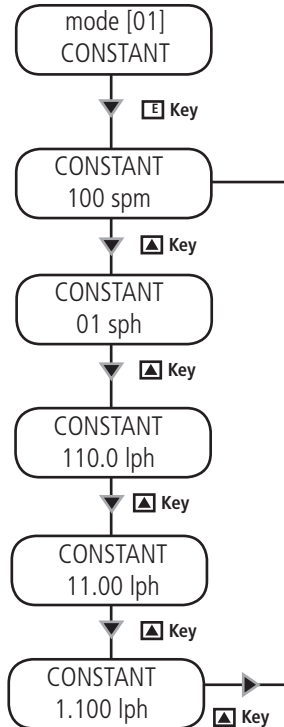

Choose "CONSTANT" working mode: "SPH" (strokes per hour), "SPM" (strokes per minute), "LPH" (litres per hour).

Use "UP" key to choose between these two modes. Use "RIGHT" key to change value. For next digit press again "RIGHT" key.

"LPH" value accuracy depends on cc/st value set into the Setup menu (SET [01] CC/ST).

LPH max value depends on the max frequency of the pump (refer to the pump's label). If an higher value is set, the pump will show an alarm message (ALARM STROKE).

Press "E" key to save data and "ESC" to exit to main menu. Otherwise press "ESC" to discard data and exit to main menu.

Note: last mode displayed before press the "E" key will be the active one.

## 19. "DIVIDE" working mode

### DIVIDE mode.

External pulses are divided by a value set during program session. The pump doses with a frequency determined by this parameter.

#### Which parameters must be set ?

DIVIDE (divisor factor)

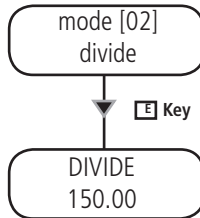

Use this mode if connected pulse sender water meter produces many pulses and pump must divide them for correct dosing activities. See formula below to verify this value.

Minimum value accepted is 001.00. Setting a lower value the pump does not save the data.

Use "UP" key to modify the value. Press "RIGHT" key to move on next digit.

Press "E" key to save data and "ESC" to exit to main menu. Otherwise press "ESC" to discard data and exit to main menu.

#### Use the following formula to find the divider to keep desired concentration.

$$\left( \frac{[\text{imp/l}] \times [\text{cc}]}{[\text{ppm}] \times [\text{K}]} \right) \times 1000 = N$$

N - divisor value to enter into the pump  
[imp/l]- pulses/liter from pulse sender water meter  
[cc] - single injection quantity of dosing pump  
[ppm] - part per millions product quantity to dose (gr/m<sup>3</sup>)  
[K] - product dilution coefficient.  
100% of product when K=1

If obtained "N" is < 1 then install a pulse sender water meter that produces more pulses. Otherwise use the "MULTIPLY" mode and multiply for 1/N. It's also possible to fix the problem trying to decrease product dilution.

## 20. "MULTIPLY" working mode

### MULTIPLY mode.

External pulses are multiplied by a value set during program session. The pump doses with a frequency determined by this parameter.

#### Which parameters must be set ?

MULTIPLY (multiply factor)  
TIMEOUT

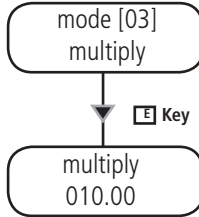

Use this mode if: connected pulse sender water meter produces few pulses and pump must multiply them for correct dosing activities. See formula below to verify this value.

Minimum value accepted is 001.00. Setting a lower value the pump does not save the data.

Use "UP" key to modify the value. Press "RIGHT" key to move on next digit.

Press "E" key to save data and "ESC" to exit to main menu. Otherwise press "ESC" to discard data and exit to main menu.

**Use the following formula to find the divider to keep desired concentration.**

$$\left( \frac{[\text{ppm}] \times [\text{K}]}{([\text{imp/l}] \times [\text{cc}]) \times 1000} \right) = \text{N}$$

N - multiplier value to enter into the pump  
[imp/l]- pulses/liter from pulse sender water meter  
[cc] - single injection product quantity of dosing pump  
[ppm] - part per millions product quantity to dose (gr/m<sup>3</sup>)  
[K] - product dilution coefficient.  
100% of product when K=1

If obtained "N" is < 1 then install a pulse sender water meter that produces less pulses. Otherwise use the "DIVIDE" mode and divide for 1/N. It's also possible to fix the problem trying to decrease product dilution.

Note: before to use this mode please set the "TIMEOUT" parameter as described at page 26.

## 21. "PPM" working mode

### PPM mode.

Dosing rate is determined by pulses from a water meter, PPM, chemical product (%) concentration and quantity for each single stroke set during program session.

#### Which parameters must be set ?

PPM (parts per million product quantity)

CONC (% of product's concentration)

TIMEOUT

WMETER (pulse sender water meter)

CC/ST (see related page)

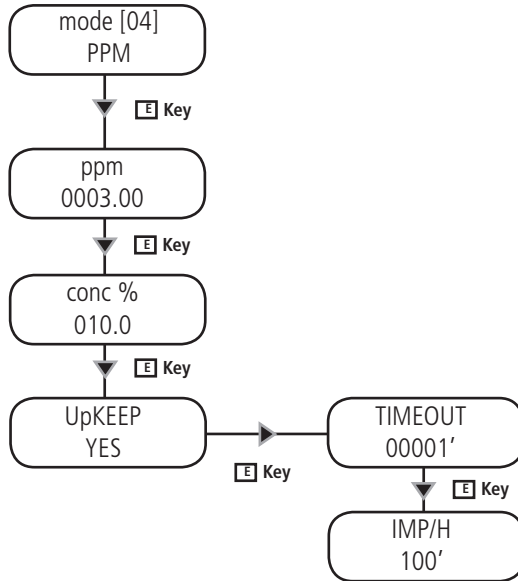

Use **"UP"** key to change selected unit ("\_" blinking cursor) of PPM.

To move on next digit press **"RIGHT"** key.

To modify quantity of product concentration press **"E"** key.

Use **"UP"** key to change selected unit ("\_" blinking cursor) of CONC%.

To move on next digit press **"RIGHT"** key.

Press **"E"** key to save data and **"ESC"** to exit to main menu. Otherwise press **"ESC"** to discard data and exit to main menu.

To change **"TIMEOUT"** option, pump activation without external pulses for a set time, choose **"YES"** from **"UPKEEP"** menu. Then set pulses/hour to dose at the end of set time.

Note: before to use this mode we suggest to set the **"TIMEOUT"** parameter. **"TIMEOUT"** take part when the result is a multiplication.

## 22. "PERC" working mode

### PERC mode.

Dosing rate is determined by pulses from a water meter, percentage (%), chemical product concentration and quantity for each single stroke set during program session.

Which parameters must be set ?

% (percentage of product quantity to dose)

CONC (% of product's concentration): set 100% if product is pure

CC/STROKE (refer to CC/ST setup)

WMETER (water meter)

TIMEOUT

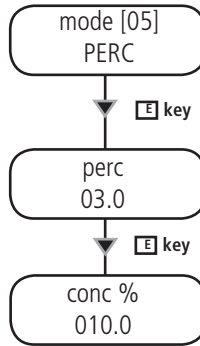

Selectable from 0.1 to 100.0%

Use **"UP"** key to change selected unit ("\_" blinking cursor) of PPM.

To move on next digit press **"RIGHT"** key.

To modify quantity of product concentration press **"E"** key.

Use **"UP"** key to change selected unit ("\_" blinking cursor) of CONC%.

To move on next digit press **"RIGHT"** key.

Press **"E"** key to save data and **"ESC"** to exit to main menu. Otherwise press **"ESC"** to discard data and exit to main menu.

Note: before to use this mode we suggest to set the "TIMEOUT" parameter.  
"TIMEOUT" take part when the result is a multiplication.

## 23. "MLQ" working mode

### MLQ mode.

Dosing rate is determined by pulses from a water meter on the base of set MLQ (milliliters per quintal), chemical product concentration (%) and quantity for each single stroke set during program session.

Which parameters must be set ?

MLQ (product quantity in milliliters per quintal)

CONC (% of product's concentration): set 100% if product is pure

CC/STROKE (refer to CC/ST setup)

WMETER (water meter)

TIMEOUT

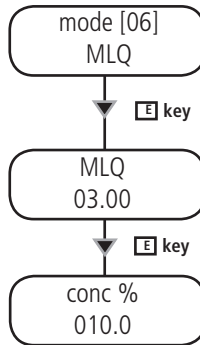

Use **"UP"** key to change selected unit ("\_" blinking cursor) of MLQ.

To move on next digit press **"RIGHT"** key.

To modify quantity of product concentration press **"E"** key.

Use **"UP"** key to change selected unit ("\_" blinking cursor) of CONC%.

To move on next digit press **"RIGHT"** key.

Press **"E"** key to save data and **"ESC"** to exit to main menu. Otherwise press **"ESC"** to discard data and exit to main menu.

Note: before to use this mode we suggest to set the "TIMEOUT" parameter.  
"TIMEOUT" take part when the result is a multiplication.

## 24. "BATCH" working mode

### BATCH mode.

Signal from an external contact starts the pump to dose the needed quantity set during program session or for the set number of strokes.

#### When to use this mode ?

This function allows to begin dosing activities when pump receives an external signal or to dose in WORK-PAUSE mode.

#### Which parameters must be set ?

MODE (EXTERNAL - MANUAL - INTERNAL)

ST (strokes)

CC (product's quantity to dose only if programmed to feed a set amount of chemical)

CC/STROKE (see "setup CC/ST")

CONTACT (OPEN or CLOSED)

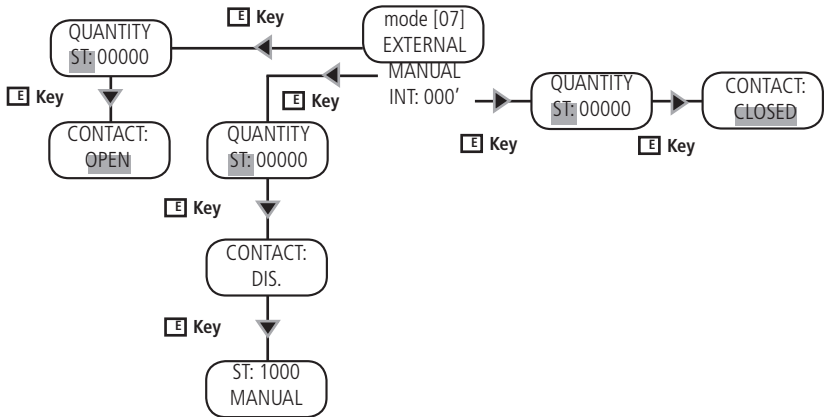

Choose working mode:

**EXTERNAL:** Pump doses within an amount of time if an external signal is received. External contact can be set as OPEN (normally open) or CLOSED. (normally closed). Press "E" from main mode, choose to dose in ST or CC using "UP" key. Set quantity dose and press "E" to continue. Define contact type using "UP" key. Press "E" to end procedure.

**MANUAL:** Pump doses at the end of procedure. Press "E" from main mode, choose to dose in ST or CC using "UP" key. Set quantity to dose. Press "E" to continue, review contact status and press "E". Pump will begin to dose immediately showing quantity left.

**INTERNAL:** This is a "WORK-PAUSE" mode. Dosing will start for set CC or ST quantity and will stop for set time. Press "E" from main mode, choose to dose in ST or CC using "UP" key. Set quantity dose and press "E" to continue. Define contact type (OPEN or CLOSED) using "UP" key. Press "E" to end procedure.

**NOTE:** Pump must be calibrated ("TEST" function) in order to work properly into this mode. It's not possible to program the pump for both modes. Last entry overwrite previous ones.



## 25. "VOLT" working mode

### VOLT mode.

Voltage from an external device drives the pump that doses proportionally using a minimum and maximum of strokes for minute set during program session.

#### Which parameters must be set ?

HIV (maximum tension)

LOV (minimum tension)

SPM (strokes per minute)

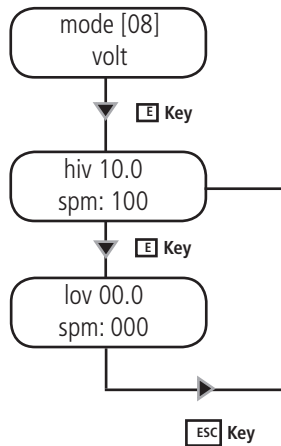

To work in this mode is necessary to specify the "HIV" (maximum working tension), "LOV" (minimum working tension) and "SPM" (strokes per minute) values that pump will produce between the parameters.

To setup this values enter into "VOLT" mode. The cursor will blink on first digit ("HIV" field). Insert maximum tension value that will be supplied to the pump ("UP" key). To move on next digit press "RIGHT" key.

The cursor will blink on "SPM" field. Insert strokes per minute that pump will produce near "HIV" value ("UP" key). To move on next digit press "RIGHT" key.

Press "E" key to move on "LOV".

The cursor will blink on first digit ("LOV" field). Insert minimum tension value that will be supplied to the pump ("UP" key). To move on next digit press "RIGHT" key.

The cursor will blink on "SPM" field. Insert strokes per minute that pump will produce near "LOV" value ("UP" key). To move on next digit press "RIGHT" key.

Press "E" key to save data and "ESC" to exit to main menu. Otherwise press "ESC" to discard data and exit to main menu.

**Attention:** if a wrong data is set (for example, it has been set the same value for HIV and LOV) an error message (WRONG ENTRY) will appear.

## 23. "mA" working mode

### mA mode.

Current from an external device drives the pump that doses proportionally using a minimum and maximum of strokes for minute set during program session.

#### Which parameters must be set ?

HImA (maximum current)

LOmA (minimum current)

SPM (strokes per minute)

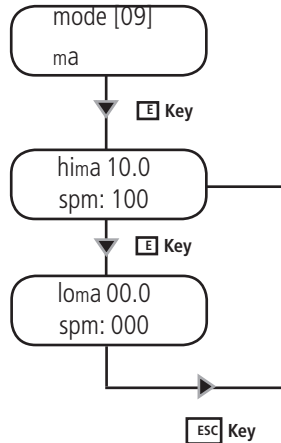

To work in this mode is necessary to specify the "HImA" (maximum working current), "LOmA" (minimum working current) and "SPM" (strokes per minute) values that pump will produce between the parameters.

To setup this values enter into "mA" mode. The cursor will blink on first digit ("HImA" field). Insert maximum current value that will be supplied to the pump ("UP" key). To move on next digit press "RIGHT" key.

The cursor will blink on "SPM" field. Insert strokes per minute that pump will produce near "HImA" value ("UP" key). To move on next digit press "RIGHT" key.

Press "E" key to move on "LOmA".

The cursor will blink on first digit ("LOmA" field). Insert minimum current value that will be supplied to the pump ("UP" key). To move on next digit press "RIGHT" key.

The cursor will blink on "SPM" field. Insert strokes per minute that pump will produce near "LOmA" value ("UP" key). To move on next digit press "RIGHT" key.

Press "E" key to save data and "ESC" to exit to main menu. Otherwise press "ESC" to discard data and exit to main menu.

**Attention:** if a wrong data is set (for example, it has been set the same value for HIV and LOV) an error message (WRONG ENTRY) will appear.

## 24. STATISTICS management

### Stat.



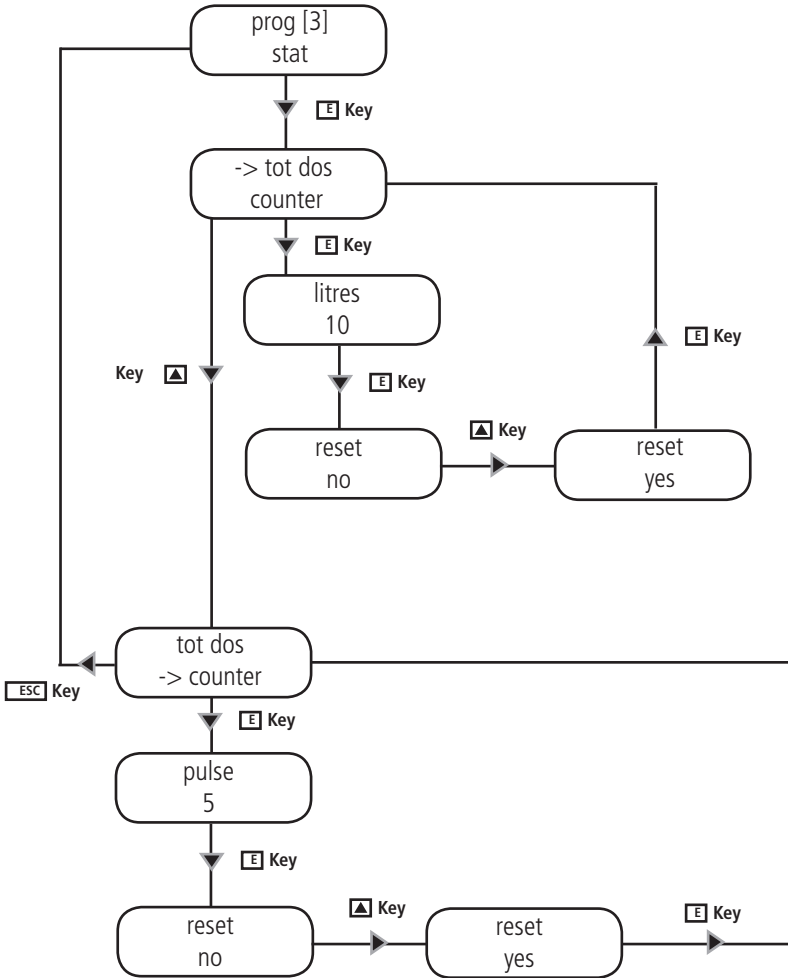

To see dosing statistics choose "STAT" from main menu. See quick guide at pag. 21



"TOD DOS" means total dosed product since pump last reset.

"COUNTER" means strokes numbers since pump last reset.

## 25. Troubleshooting

PROBLEM	CAUSE	HOW MANAGE
Pump does not turn on	<ul style="list-style-type: none"> <li>• There is not power supply.</li> <li>• Protection fuse is broken</li> <li>• Main board failure</li> </ul>	<ul style="list-style-type: none"> <li>• Connect pump to main supply</li> <li>• Replace fuse, see  <b>Fuse replacement procedure.</b></li> <li>• Replace circuit, see  <b>Main board replacement procedure.</b></li> </ul>
Pump is not dosing but solenoid is operating	<ul style="list-style-type: none"> <li>• Foot filter is obstructed</li> <li>• Unprimed pump (suction hose is empty)</li> <li>• Air bubbles in the hydraulic circuit</li> <li>• Product to dose is generating gas</li> </ul>	<ul style="list-style-type: none"> <li>• Clean foot filter</li> <li>• Prime the pump, see  <b>How to prime pump head</b></li> <li>• Check valves, hoses and fittings and let air flow away</li> <li>• Turn on venting valve and let air flow away. Use a self-venting pump head model.</li> </ul>
Pump is not dosing and solenoid isn't operating or slightly operating.	<ul style="list-style-type: none"> <li>• Crystals block the balls inside the valves</li> <li>• Injection valve obstructed</li> </ul>	<ul style="list-style-type: none"> <li>• Clean valves and try to dose 2-3 liters of normal water</li> <li>• Change valves</li> </ul>
Display shows ERROR MEM	Error in data storage	Restore default value, see  <b>LOAD DEFAULT procedure.</b>
Display shows ERROR DATA	Error in data setting	Check the value set. If correct and the error still persist, the pump could be undersized
Display shows WRONG PASSWORD	Error in password enter	Restore a new password, see  <b>RESET PASSWORD procedure</b>
Display shows INPUT OPEN	In mA and VOLT working mode only: no signal input	Check INPUT signal

## 26. Fuse and main board replacement

Fuse or main board replacement is allowed to qualified personnel only. Before to operate disconnect the pump from main power and all hydraulic connections.

For fuse replacement is necessary to use a 3x16 and 3x15 screwdriver and a new fuse (same model of old one).

For main board replacement is necessary to use a 3x16 and 3x15 screwdriver and a new main board (same model of old one).

### **Fuse replacement procedure:**

- Remove 6 screws from pump's back.
- Pull pump's back cover until it's completely separated from pump's front.
- Locate the blown fuse and replace it.
- Reassemble the pump.
- Reinsert screws.

### **Main board replacement procedure:**

- Remove 6 screws from pump's back.
- Pull pump's back cover until it's completely separated from pump's front.
- Remove board's screws.
- Completely disconnect wires from main board and replace it. Reinsert screws.
- Reconnect wires to the main board (see enclosed picture).
- Reassemble the pump.
- Reinsert screws.

# 27. Main Board

115 - 230 VAC VERSION

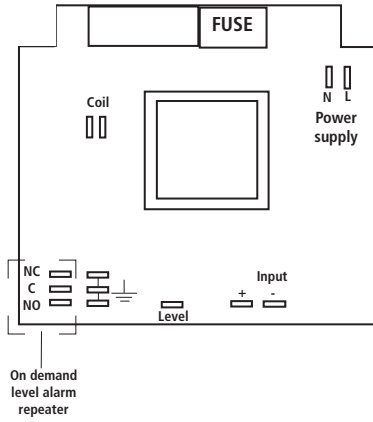

12 VDC - 24 VDC VERSION

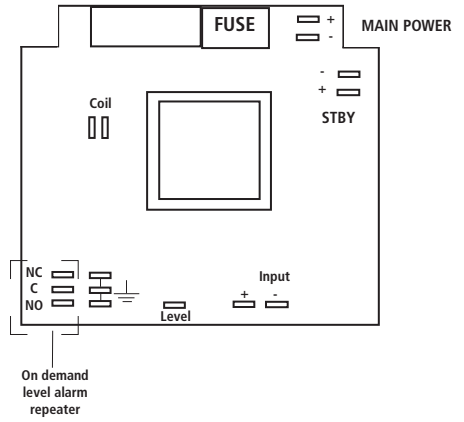

VMS MF FOR WATER METER WITH HALL EFFECT CONNECTION

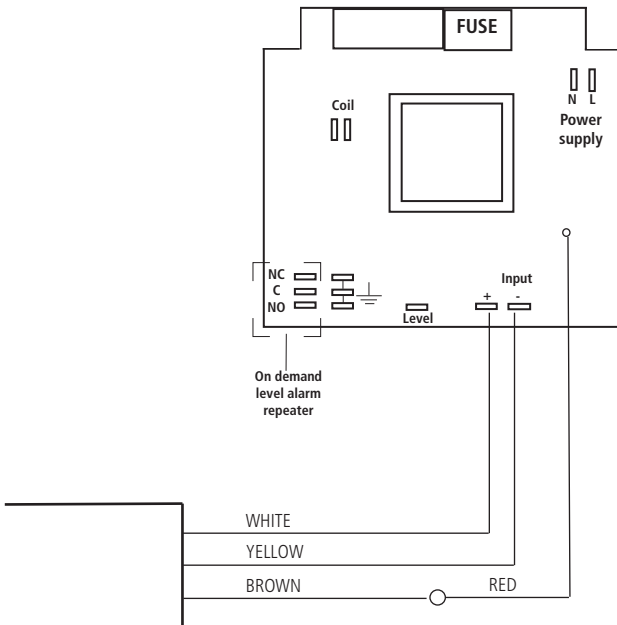

## A Appendix. Maintenance.

Maintenance  
schedule

**⚠** In order to ensure the requirements of potable drinking water treated and the maintenance of the improvements as declared by the manufacturer, this equipment must be checked at least once a month.

**⚠** OPERATOR PROTECTION

Use safety equipment according to the company regulations.  
Use this safety equipment within the work area during installation, service and when handling chemicals:

- protective mask
- protective gloves
- safety goggles
- ear plugs or hear muffs
- further security device, if necessary.

**⚠** POWER SUPPLY DISCONNECTION

Always disconnect power to the motor before you perform any installation or maintenance tasks. Failure to disconnect power will result in serious physical injury.

**⚠** Installation and maintenance tasks should be carried out by AUTHORIZED AND QUALIFIED PERSONNEL only in accordance with local regulations.

**i** Use original spare parts.

---

Maintenance  
inspection

**⚠** Shutdown the dosing pump before any maintenance operation  Shutdown procedure.

A maintenance schedule includes these types of inspections:

- Routine maintenance and inspections
- Three-month inspections
- Annual inspections

Shorten the inspection intervals appropriately if the pumped chemical is abrasive or corrosive.

### Routine maintenance and inspections

Perform these tasks whenever you perform routine maintenance:

- Inspect the seal. Ensure that there are no leaks from the mechanical seal.
- Check electrical wiring
- Check for unusual noise and vibration (noise allowed 70.4 dB(A);  $\pm 5$  dB).
- Check the pump and piping for leaks.
- Check for corrosion on parts of the pump and / or on hoses.

### Three-month inspections

Perform these tasks every three months:

- Check that the tightenings.
- Check the mechanical seal if the pump has been left idle.

### Annual inspections

Perform these inspections one time each year:

- Check the pump capacity (as per nameplate).
- Check the pump pressure (as per nameplate).
- Check the pump power (as per nameplate).

f the pump performance does not satisfy your process requirements, and the process requirements have not changed, then perform these steps:

1. Disassemble the pump.
2. Inspect it.
3. Replace worn parts.

Shutdown  
procedure

---

**⚠ This procedure SHOULD BE CARRIED OUT BY AUTHORIZED AND QUALIFIED PERSONNEL**

**⚠ OPERATOR PROTECTION**

**Use safety equipment according to the company regulations.**

**Use this safety equipment within the work area during installation, service and when handling chemicals:**

- **protective mask**
- **protective gloves**
- **safety goggles**
- **ear plugs or hear muffs**
- **further security device, if necessary.**

Shutdown the dosing pump **before any maintenance operation** or **before long downtimes**. Disconnect power and ensure it cannot be restarted.

**⚠ Depressurize the system. The liquid may leak splashing.**

Drain the chemical from pump head.

Release the pressure and disconnect the discharge pipe from the discharge valve.

Rinse the pump head and clean all valves.



## B Appendix. Construction Materials and Technical info

### TECHNICAL FEATURES

Power supply:	230 VAC (190-265 VAC) - 50/60 Hz
Power supply:	115 VAC (90-135 VAC) - 50/60 Hz
Power supply:	24 VAC (20-32 VAC) - 50/60 Hz
Power supply:	12 VDC (10-16 VDC)
Pump Strokes:	0 - 180
Suction Height:	1,5 metres
Environment Temperature:	0 - 45°C (32 - 113°F)
Chemical Temperature:	0 - 50°C (32 - 122°F)
Installation Class:	II
Pollution Level:	2
Audible Noise:	70.4 db(A)
Packaging and Transporting Temperature:	-10 - 50°C (14 - 122°F)
Protection degree:	IP 65

### MANUFACTURING MATERIALS

Case:	PPO
Pump head:	PVDF
Diaphragm:	PTFE
Balls:	CERAMIC, GLASS, PTFE, SS *
Suction Pipe	PVC
Delivery Pipe:	PE
Valve Body:	PVDF
O-ring:	FP, EP, WAX, SI, PTFE *
Injection connector	PP, PVDF (ceramic, HASTELLOY C276 spring)
Level Probe:	PP, PVDF *
Level probe cable:	PE
Foot Filter:	PP, PVDF *

\* as ordered.

VMS MF										
Model	Flow		Stroke capacity	Stroke per min	Max pressure		Max Current		Hoses	Pump Head
	max l/h	Max GPH			bar	PSI	230 VAC	115 VAC		
2001	0.09	0.26	0.09	180	20	290	2.3	1.45	4 x 8	j
1802	0.19	0.53	0.19	180	18	261	2.3	1.45	4 x 6	k
1804	0.37	1.06	0.37	180	18	261	3.2	1.9	4 x 6	k
1502	0.19	0.53	0.19	180	15	218	2.7	1.3	4 x 6	k
1504	0.37	1.06	0.37	180	15	218	2.7	1.45	4 x 6	k
1505	0.46	1.32	0.46	180	15	218	3.2	1.9	4 x 6	k
1004	0.37	1.06	0.37	180	10	145	2.7	1.3	4 x 6	k
1005	0.46	1.32	0.46	180	10	145	2.7	1.45	4 x 6	k
1010	0.93	2.64	0.93	180	10	145	3.2	1.9	4 x 6	k
0706	0.56	1.59	0.56	180	07	102	2.7	1.3	4 x 6	k
0510	0.93	2.64	0.93	180	05	73	2.7	1.45	4 x 6	k
0512	1.11	3.17	1.11	180	05	73	3.2	1.9	4 x 6	k
0408	0.74	2.11	0.74	180	04	58	2.7	1.3	4 x 6	k
0310	0.93	2.64	0.93	180	03	44	2.7	1.3	4 x 6	k
0215	1.39	3.96	1.39	180	02	29	3.2	1.9	6 x 8	k
0116	1.48	4.23	1.48	180	01	15	2.7	1.45	6 x 8	k

VMSA MF							
	Flow			Stroke capacity	Max pressure		Pump Head
	min cc/h	max l/h	Max GPH		bar	PSI	
<b>1802</b>	0.19	2	0.52	0.19	18	261	KA
<b>1503</b>	0.28	3	0.79	0.28	18	217	KA
<b>1501</b>	0.09	1	0.26	0.1	15	217	KA
<b>103.4</b>	0.31	3.4	0.89	0.32	10	145	KA
<b>1007</b>	0.65	7	1.84	0.65	10	145	KA
<b>1002</b>	0.19	2	0.52	0.19	10	145	KA
<b>0704</b>	0.37	4	1.05	0.37	7	101	KA
<b>057.5</b>	0.69	7.5	1.98	0.7	5	72	KA
<b>0509</b>	0.83	9	2.37	0.84	5	72	KA
<b>045.5</b>	0.51	5.5	1.45	0.51	4	58	KA
<b>0307</b>	0.65	7	1.84	0.65	3	43	KA
<b>0212</b>	1.1	12	3.17	1.11	2	29	KA
<b>0113,5</b>	1.25	13.5	3.56	1.25	1	14	KA

VMS MF FUSE VALUE		
MOD.	230 VAC	115 VAC
<b>2001</b>	1 A	500 mA
<b>1802</b>	1 A	500 mA
<b>1804</b>	1.25 A	630 mA
<b>1502</b>	800 mA	400 mA
<b>1504</b>	1 A	500 mA
<b>1505</b>	1.25 A	630 mA
<b>1004</b>	800 mA	400 mA
<b>1005</b>	1 A	500 mA
<b>1010</b>	1.25 A	630 mA
<b>0706</b>	800 mA	400 mA
<b>0510</b>	1 A	500 mA
<b>0512</b>	1.25 A	630 mA
<b>0501</b>	800 mA	400 mA
<b>0408</b>	800 mA	400 mA
<b>0310</b>	800 mA	400 mA
<b>0215</b>	1.25 A	630 mA
<b>0116</b>	1 A	500 mA

VMSA MF FUSE VALUE		
	230 VAC	115 VAC
<b>1802</b>	1.25 A	1.25 A
<b>1503</b>	1.25 A	1.25 A
<b>1501</b>	800 mA	800 mA
<b>103,4</b>	1 A	1 A
<b>1007</b>	1.25 A	1.25 A
<b>1002</b>	800 mA	800 mA
<b>0704</b>	800 mA	800 mA
<b>057,5</b>	1 A	1 A
<b>0509</b>	1.25 A	1.25 A
<b>045,5</b>	800 mA	800 mA
<b>0307</b>	800 mA	800 mA
<b>0212</b>	1.25 A	1.25 A
<b>0113,5</b>	1 A	1 A

# C Appendix. Delivery Curves

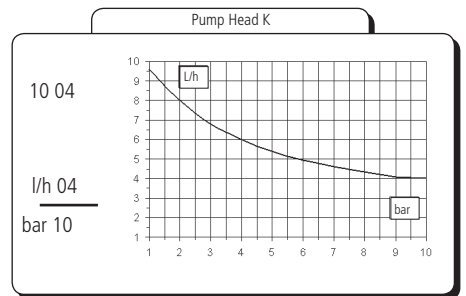
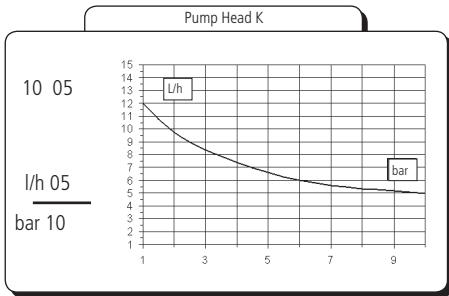
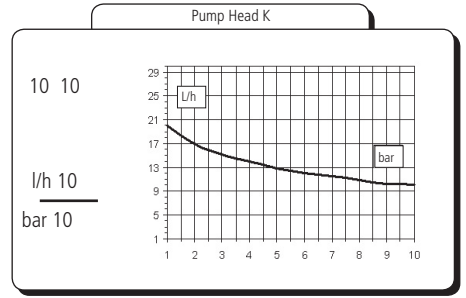
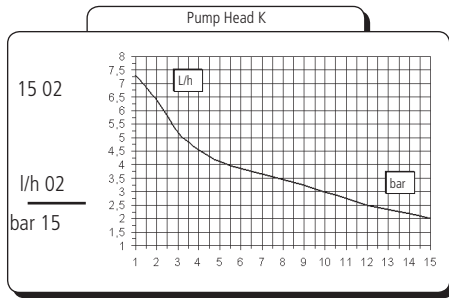
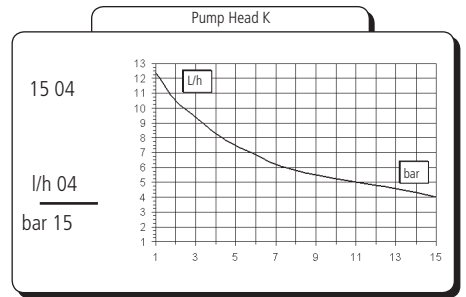
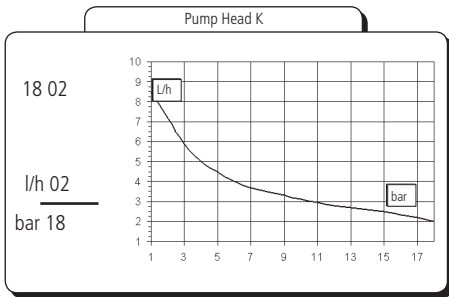
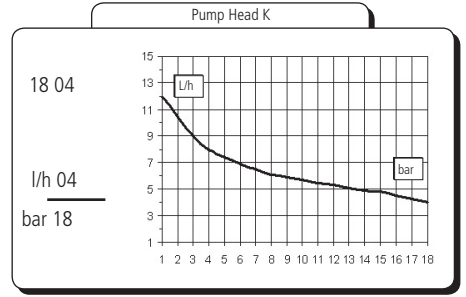
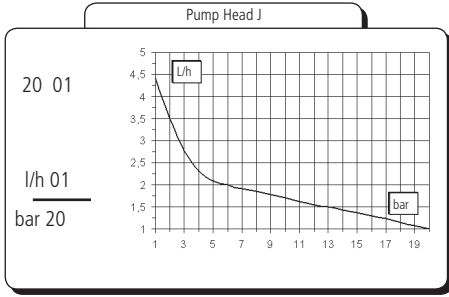

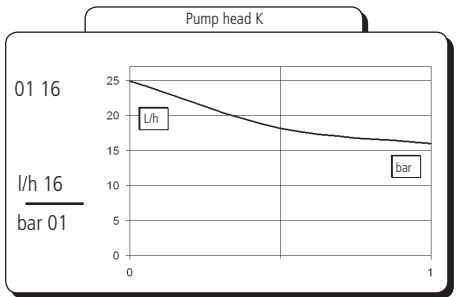
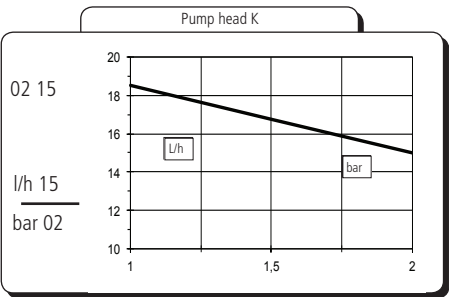
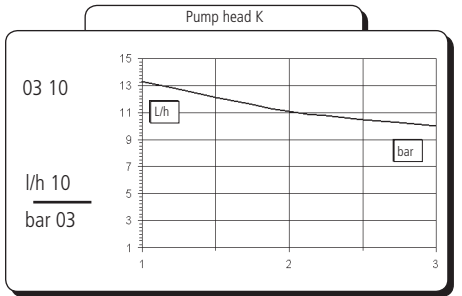
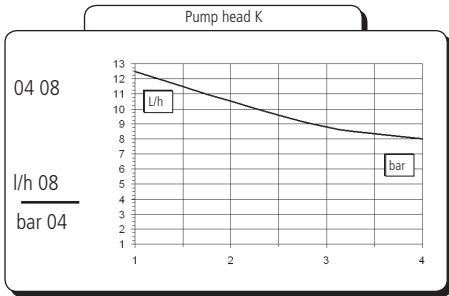
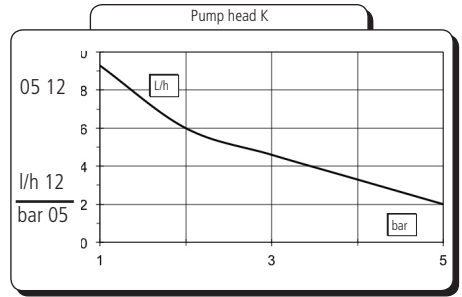
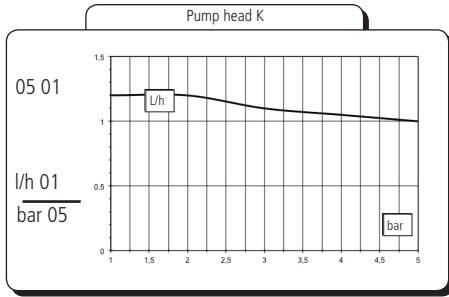
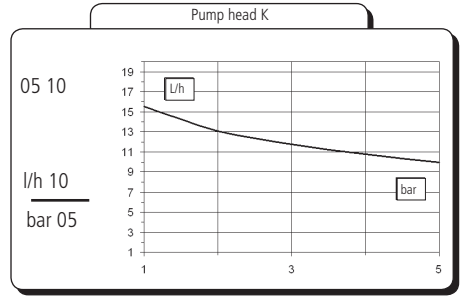
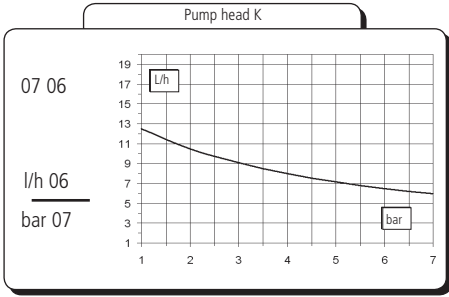

Flow rate indicated is for H<sub>2</sub>O at 20°C at the rated pressure.  
Dosing accuracy ± 2% at constant pressure ± 0,5 bar.

# C Appendix. Self-Venting Delivery Curves

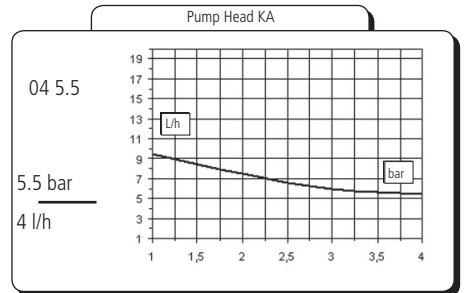
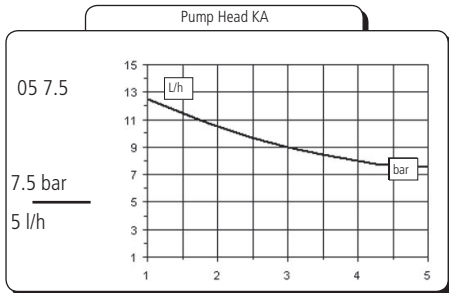
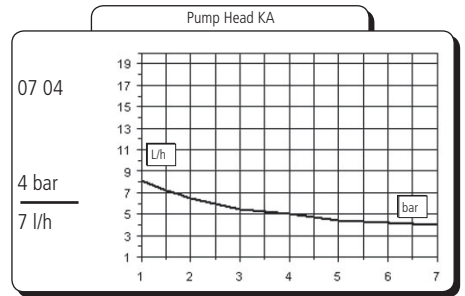
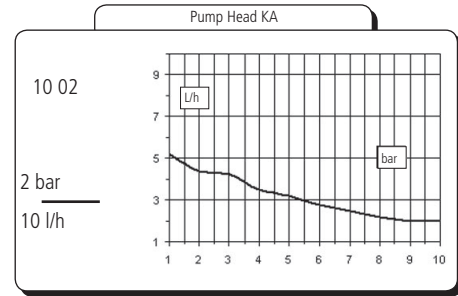
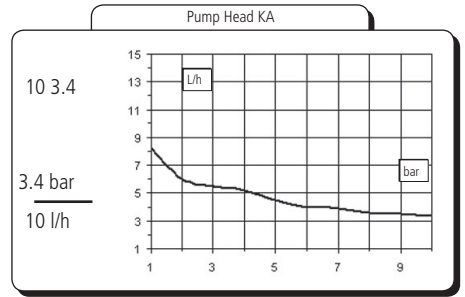
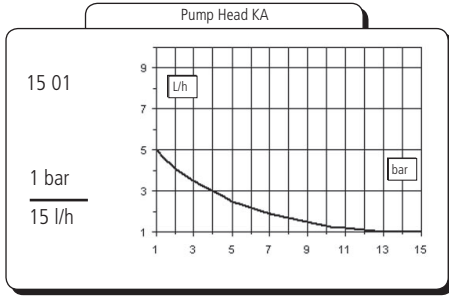
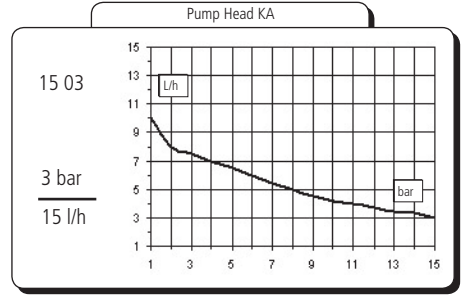
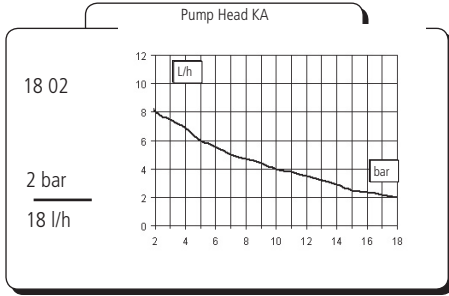

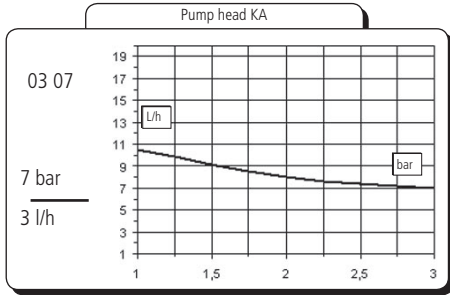

Flow rate indicated is for H<sub>2</sub>O at 20°C at the rated pressure. Dosing accuracy  $\pm 2\%$  at constant pressure  $\pm 0,5$  bar.

## D Appendix. Dimensions

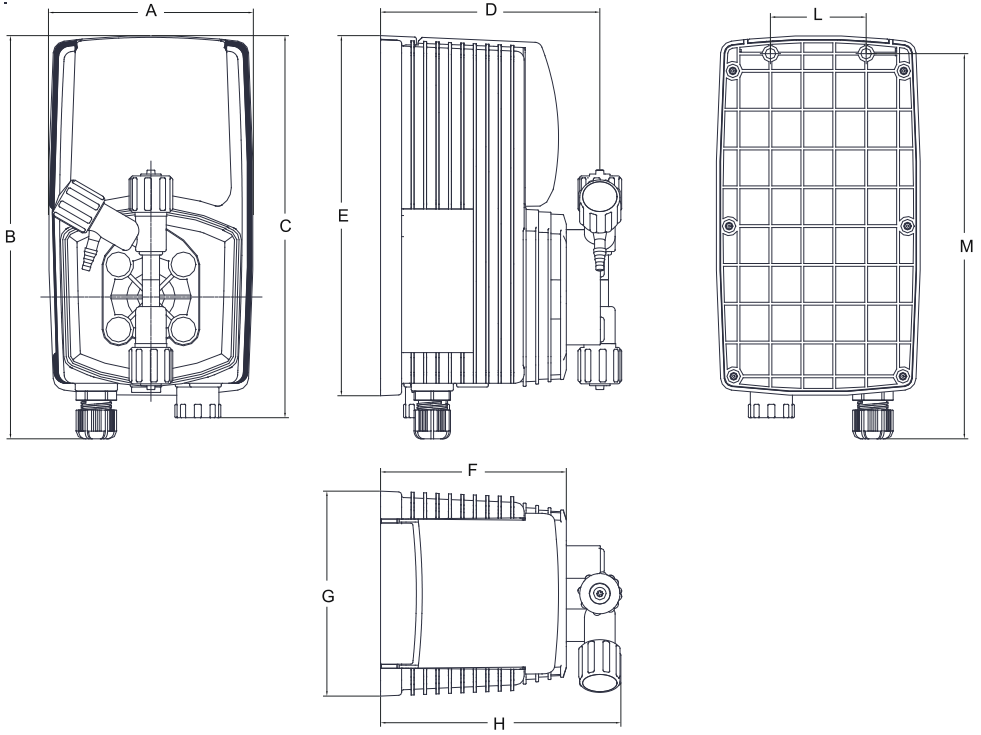

DIMENSIONS		
	<i>mm</i>	<i>inch</i>
<i>A</i>	106.96	4.21
<i>B</i>	210.44	8.28
<i>C</i>	199.44	7.85
<i>D</i>	114.50	4.50
<i>E</i>	187.96	7.40
<i>F</i>	97.00	3.81
<i>G</i>	106.96	4.21
<i>H</i>	125.47	4.93
<i>L</i>	50.00	1.96

## E Appendix. Chemical Compatibility Table

Chemical compatibility table

Solenoid driven metering pumps are widely used to dose chemical fluids and it is important that the most suitable material in contact with fluid is selected for each application. This compatibility table serves as a useful help in this respect. All the informations in this list are verified periodically and believed to be correct on the date of issuance. All the informations in this list are based on manufacturer's data and its own experience but since the resistance of any material depends by several factors this list is supplied only as an initial guide, in no way manufacturer makes warranties of any matter respect to the informations provided in this list.

Tab. 1. Chemical compatibility table.

Product	Formula	Ceram.	PVDF	PP	PVC	SS 316	PMMA	Hastel.	PTFE	FPM	EPDM	NBR	PE
Acetic Acid, Max 75%	CH <sub>3</sub> COOH	2	1	1	1	1	3	1	1	3	1	3	1
Hydrochloric Acid, Concentrate	HCl	1	1	1	1	3	1	1	1	1	3	3	1
Hydrofluoric Acid 40%	H <sub>2</sub> F <sub>2</sub>	3	1	3	2	3	3	2	1	1	3	3	1
Phosphoric Acid, 50%	H <sub>3</sub> PO <sub>4</sub>	1	1	1	1	2	1	1	1	1	1	3	1
Nitric Acid, 65%	HNO <sub>3</sub>	1	1	2	3	2	3	1	1	1	3	3	2
Sulphuric Acid, 85%	H <sub>2</sub> SO <sub>4</sub>	1	1	1	1	2	3	1	1	1	3	3	1
Sulphuric Acid, 98.5%	H <sub>2</sub> SO <sub>4</sub>	1	1	3	3	3	3	1	1	1	3	3	3
Amines	R-NH <sub>2</sub>	1	2	1	3	1	-	1	1	3	3	1	1
Sodium Bisulphite	NaHSO <sub>3</sub>	1	1	1	1	2	1	1	1	1	1	1	1
Sodium Carbonate (Soda)	Na <sub>2</sub> CO <sub>3</sub>	2	1	1	1	1	1	1	1	2	1	1	1
Ferric Chloride	FeCl <sub>3</sub>	1	1	1	1	3	1	1	1	1	1	1	1
Calcium Hydroxide (Slaked Lime)	Ca(OH) <sub>2</sub>	1	1	1	1	1	1	1	1	1	1	1	1
Sodium Hydroxide (Caustic Soda)	NaOH	2	1	1	1	1	1	1	1	2	1	2	1
<sup>1</sup> Calcium Hypochlor.(Chlor.ted Lime)	Ca(OCl) <sub>2</sub>	1	1	1	1	3	1	1	1	1	1	3	1
Sodium Hypochlorite, 12.5%	NaOCl + NaCl	1	1	2	1	3	1	1	1	1	1	2	2
Potassium Permanganate, 10%	KMnO <sub>4</sub>	1	1	1	1	1	1	1	1	1	1	3	1
Hydrogen Peroxide, 30% (Perydrol)	H <sub>2</sub> O <sub>2</sub>	1	1	1	1	1	3	1	1	1	3	3	1
Aluminium Sulphate	Al <sub>2</sub> (SO <sub>4</sub> ) <sub>3</sub>	1	1	1	1	1	1	1	1	1	1	1	1
Copper-II-Sulphate (Roman Vitriol)	CuSO <sub>4</sub>	1	1	1	1	1	1	1	1	1	1	1	1

<sup>1</sup> Calcium Hypochlor.(Chlor.ted Lime): WQA test was based on 1% Calcium Hypochlorite solution.

- 1 - Good resistance rating
- 2 - Fairly resistance rating
- 3- Not resistant

Materials

Polyvinylidene fluoride (PVDF) .....Pump heads, Valves, Fittings  
 Polypropylene (PP).....Pump heads, Valves, Fittings  
 PVC .....Pump heads  
 Stainless steel (SS 316).....Pump heads, Valves  
 Polymethyl Metacrilate Acrylic (PMMA) ...Pump heads  
 Polytetrafluoroethylene (PTFE) .....Diaphragm  
 Fluorocarbon (FPM).....O-ring  
 Ethylene propylene (EPDM).....O-ring  
 Nitrile (NBR).....O-ring



## F Appendix. Hoses resistance table

Hose features are very important for a reliable dosage. Every pump's model is made to work in the best way using selected hoses according to pump's capacity / model. Information reported here are intended for standard use only. For extended information ask to hose's manufacturer.

<b>Suction / Delivery Hose</b>			
<b>4x6 mm PVC (transparent)</b>	<b>4x8 mm PE (opaque)</b>	<b>6x8 mm PE (opaque)</b>	<b>8x12 mm PVC (transparent)</b>

<b>Delivery Hose</b>	<b>Working Pressure</b>				<b>Breaking Pressure</b>			
<b>4x6 mm PE 230 (opaque)</b>	20°C 12 bar	30°C 10.5 bar	40°C 8.5 bar	50°C 6.2 bar	20°C 36 bar	30°C 31.5 bar	40°C 25.5 bar	50°C 18.5 bar
<b>4x8 mm PE 230 (opaque)</b>	20°C 19 bar	30°C 15.7 bar	40°C 12 bar	50°C 7.5 bar	20°C 57 bar	30°C 47 bar	40°C 36 bar	50°C 22.5 bar
<b>6x8 mm PE 230 (opaque)</b>	20°C 8.6 bar	30°C 6.8 bar	40°C 4.8 bar	50°C 2.3 bar	20°C 26 bar	30°C 20.5 bar	40°C 14.5 bar	50°C 7 bar
<b>8x12 mm PE 230 (opaque)</b>	20°C 12 bar	30°C 10.5 bar	40°C 8.5 bar	50°C 6.2 bar	20°C 36 bar	30°C 31.5 bar	40°C 25.5 bar	50°C 18.5 bar
<b>4x6 mm PVDF Flex 2800 (opaque)</b>	20°C 40 bar	30°C 34 bar	40°C 30 bar	50°C 27 bar	60°C 24.8 bar	80°C 20 bar	90°C 10 bar	
<b>6x8 mm PVDF Flex 2800 (opaque)</b>	20°C 29 bar	30°C 25.5 bar	40°C 22 bar	50°C 20 bar	60°C 18 bar	80°C 14.5 bar	90°C 7.3 bar	
<b>8X10 mm PVDF Flex 2800 (opaque)</b>	20°C 18 bar	30°C 15.5 bar	40°C 13.5 bar	50°C 12.5 bar	60°C 11.2 bar	80°C 9 bar	90°C 4.5 bar	
<b>1/4 PE 230 (opaque)</b>	20°C 17.6 bar							
<b>3/8 PE 230 (opaque)</b>	20°C 10.6 bar							
<b>1/2 PE 230 (opaque)</b>	20°C 10.6 bar							

**PRODUCT SERVICE REPAIR FORM**

ENCLOSE THE PRESENT FORM TO THE DELIVERY NOTE

**DATE** .....

**SENDER**  
 Company name.....  
 Address .....,.....  
 Phone no. ....  
 Contact person.....

**PRODUCT TYPE (see product label)**

DEVICE CODE .....  
S/N (serial number).....

**OPERATING CONDITIONS**

Location/installation description .....,.....  
.....  
Chemical .....,.....  
Start-up (date) ..... Running time (approx. hours).....

**REMOVE ALL THE LIQUID INTO THE PUMP HEAD AND DRY IT BEFORE PACKAGING IN ITS ORIGINAL BOX.**

**DESCRIPTION OF PROBLEM**

- MECHANICAL**  
 Wear parts.....  
 Brekage/other damages .....,.....  
 Corrosion.....  
 Other.....
- ELECTRICAL**  
 Connections, connector, cables .....,.....  
 Operating controls (keyboard, display, etc.) .....,.....  
 Elettronics.....  
 Other.....
- LEAKS**  
 Connections.....  
 Pump head .....,.....
- NOT OR INADEQUATE FUNCTION/OTHER**  
 .....  
 .....  
 .....

**I declare that the dosing pump is free of any hazardous chemical.**

## Summary

GENERAL SAFETY GUIDELINES .....	2
PURPOSE OF USE AND SAFETY .....	3
ENVIRONMENTAL SAFETY .....	4
LABELS .....	4
SPARE PARTS .....	4
1. Introduction .....	5
2. Unpacking.....	6
3. Pump's description .....	7
4. Before to Install warnings .....	8
5. Installation Draw .....	9
6. Hydraulic Installation .....	10
7. Electrical Installation.....	14
8. Basic Settings.....	16
9. Priming .....	18
10. Pump's functions summary .....	19
10. Pump's functions summary- ALARMS .....	20
11. Quick Guide - Main Menu (Prog [1] Mode).....	21
12. Quick Guide - Main Menu (Prog [2] Setup).....	22
13. Quick Guide - Main Menu (Prog [3] Stat) .....	23
15. Setup .....	24
16. "Load default" and "Reset Password" procedure .....	30
17. Working procedure setup.....	31
18. "CONSTANT" working mode .....	34
19. "DIVIDE" working mode.....	35
20. "MULTIPLY" working mode.....	36
21. "PPM" working mode .....	37
22. "PERC" working mode .....	38
23. "MLQ" working mode .....	39
24. "BATCH" working mode.....	40
25. "VOLT" working mode.....	41
23. "mA" working mode.....	42
24. STATISTICS management .....	43
25. Troubleshooting.....	44
26. Fuse and main board replacement .....	45
27. Main Board .....	46
A Appendix. Maintenance.....	47
B Appendix. Construction Materials and Technical info .....	49
C Appendix. Delivery Curves .....	50
C Appendix. Self-Venting Delivery Curves .....	52
D Appendix. Dimensions .....	54
E Appendix. Chemical Compatibility Table .....	55
F Appendix. Hoses resistance table .....	56

